

Culligan[®]

OWNERS GUIDE

Aquasential™ Smart High Efficiency Water Conditioners

Models from 2021





Analytical Laboratory Services

Water Testing Made Easy.

Culligan's Analytical Laboratory provides its customers with quality water analysis using EPA approved methods. Our Analytical Laboratory is certified by the State of Illinois EPA, to be compliant with the National Environmental Laboratory Accreditation Conference (NELAC) standards. In addition to Illinois chemical certification, our Analytical Laboratory is certified to perform coliform and E. coli testing.

We strive to provide our customers with the testing they need at the lowest possible cost with the quickest turn-around time.

STANDARD WATER TESTING

For sizing systems and general chemical water characteristics.

WELL WATER TESTING

- Basic • Realtor
- Drilling Surveillance
- Expanded
- Gold

SPECIAL WATER TESTING

- Hemodialysis • Scale
- Resin • Organic
- Microbiology
- Membrane

Contact your local Culligan Dealer today to make sure your water is it's best it can be.

1-877-889-8195

E-mail: Water.Analysis@culligan.com

www.culligan.com

You could give your people

Culligan Water™

Culligan®

Table of Contents

About This Manual.....	4
Attention Culligan Customer:.....	5
Thank You!.....	6
Specifications	8
Application & Operation.....	17
Salt Supply	21
Care & Cleaning	22
Sanitizing.....	23
Menu Navigation.....	24
When & How to Bypass Your System.....	26
Things to Check Before You Call For Service	27
Performance Data Sheets	28
Records & Data	59
Culligan Limited Warranty	60

About This Manual

This manual:

- Familiarizes the operator with the equipment
- Explains installation and setup procedures
- Provides basic programming information
- Explains the various modes of operation
- Gives specifications and troubleshooting information

Read this Manual First

Before you operate the Culligan unit, read this manual to become familiar with the device and its capabilities.

Installation or maintenance done on this system by an untrained service person can cause major damage to equipment or property damage. Not adhering to the recommended service/maintenance can cause damage to equipment or property damage.

Safety Instructions and Safety Definitions

Note

NOTE! “Note!” is used to emphasize installation, operation or maintenance information which is important, but does not present any hazard.

Caution



CAUTION!

“Caution” is used when failure to follow directions could result in damage to equipment or property.

Warning



WARNING!

“Warning” is used to indicate a hazard which could cause injury or death if ignored.

The **CAUTION** and **WARNING** paragraphs are not meant to cover all possible conditions and situations that may occur. It must be understood that common sense, caution, and careful attention are conditions which cannot be built into the equipment. These **MUST** be supplied by the personnel installing, operating, or maintaining the system.

NOTE! Be sure to check and follow the applicable plumbing codes and ordinances when installing this equipment.

WARNING! Use protective clothing and proper face or eye protection equipment when handling chemicals or power tools.

Attention Culligan Customer:

We encourage Culligan users to learn about Culligan products, but we believe that product knowledge is best obtained by consulting with your Culligan dealer. Untrained individuals who use this manual assume the risk of any resulting property damage or personal injury.



WARNING!

Electrical shock hazard! Prior to servicing equipment, disconnect power supply to prevent electrical shock.

WARNING!

If incorrectly installed, operated, or maintained, this product can cause severe injury. Those who install, operate, or maintain this product should be trained in its proper use, warned of its dangers, and should read the entire manual before attempting to install, operate, or maintain this product. Failure to comply with any warning or caution that results in any damage will void the warranty.



CAUTION!

This system is to be supplied with cold water only.

CAUTION!

This product is not to be used by children or persons with reduced physical, sensory or mental capabilities, or lack of experience or knowledge, unless they have been given supervision or instruction. Children should be instructed not to play with this appliance.

CAUTION!

If the power cord from the power supply to the unit looks or becomes damaged, the cord and power supply should be replaced by a Culligan Service Agent or similarly qualified person in order to avoid a hazard.

CAUTION!

To reduce the risk of fire, use only No. 26 AWG or larger telecommunications line cord.

NOTE! This system is not intended for use with water that is microbiologically unsafe or of unknown quality without adequate disinfection either before or after the system.

Check with your public works department for applicable local plumbing and sanitation codes. Follow local codes if they differ from the standards used in this manual. To ensure proper and efficient operation of this Culligan product to your full satisfaction, carefully follow the instructions in this manual.

Products manufactured and marketed by Culligan International Company (Culligan) and its affiliates are protected by patents issued or pending in the United States and other countries. Culligan reserves the right to change the specifications referred to in this literature at any time without prior notice. Culligan, Aqua-Sensor, Tripl-Hull, and SoftMinder are trademarks of Culligan International Company or its affiliates.

Culligan International Company

9399 West Higgins Road, Suite 1100

Rosemont, Illinois 60018

1-847-430-2800

www.culligan.com

Thank You!

Welcome To Your New World of Better Living with Culligan Water.

Congratulations on selecting the Culligan® Aquasential™ Smart High Efficiency Water Conditioner system. With Culligan's many years of knowledge and experience in water treatment, you can be confident that the model you selected has been designed and engineered to provide years of service with a minimum of care and attention.

If this is your first experience having filtered, conditioned water in your home, you'll love the amazing difference it makes. We promise that you'll never want to be without it again.

The Culligan Aquasential Smart High Efficiency Water Conditioner system is designed to meet the needs of applications for high quality water. This manual contains important information about the unit, including information needed for installation, operating, and maintenance procedures. A troubleshooting section provides a guide for quick and accurate problem solving.

This manual is based on information available at the time it was finalized, approved, and published. Continuing design refinement could cause changes that may not be included in this publication.

Your local independently operated Culligan dealer employs trained service and maintenance personnel who are experienced in the installation, function and repair of Culligan equipment. This publication is written specifically for these individuals and is intended for their use.

The Aquasential Smart High Efficiency Water Softeners have been tested and certified by WQA against NSF/ANSI Standard 372, CSA B483.1, and NSF/ANSI Standard 44 for the effective reduction of hardness (calcium and magnesium), barium, and radium 226/228, as verified and substantiated by test data. See specifications on [page 8](#) for full list of models.



The Aquasential Smart High Efficiency Upflow Water Softeners have been tested and certified by WQA against NSF/ANSI Standard 372, CSA B483.1, and NSF/ANSI Standard 44 for the effective reduction of hardness (calcium and magnesium), barium, and radium 226/228 as verified and substantiated by test data. See specifications on [page 9](#) for full list of models.

The Aquasential Smart High Efficiency Municipal Water Softeners have been tested and certified by WQA against NSF/ANSI Standard 372, CSA B483.1, and NSF/ANSI Standard 44 for the effective reduction of hardness (calcium and magnesium), barium, and radium 226/228, and NSF/ANSI Standard 42 for the effective reduction of Chlorine Taste and Odor, as verified and substantiated by test data. See specifications on [page 10](#) for full list of models.

The Aquasential Smart High Efficiency Softener-Clear water softeners and Aquasential Smart High Efficiency Softener-Clear Plus water softeners have been tested and certified by WQA against CSA B483.1, NSF/ANSI Standard 372, NSF/ANSI Standard 44 for the effective reduction of hardness (calcium and magnesium), barium, and radium 226/228, and NSF/ANSI 42 for the effective Iron Reduction up to 11 ppm, as verified and substantiated by test data. See specifications on [page 11](#) and [page 12](#) for full list of models.

The Aquasential Smart High Efficiency Twin Water Softeners have been tested and certified by the WQA against NSF/ANSI Standard 372, CSA B483.1, and NSF/ANSI Standard 44 for the effective reduction of hardness (calcium and magnesium), barium, and radium 226/228, as verified and substantiated by test data. See specifications on [page 13](#) for full list of models.

The Aquasential Smart High Efficiency Twin Upflow Water Softeners have been tested and certified by the WQA against NSF/ANSI Standard 372, CSA B483.1, and NSF/ANSI Standard 44 for the effective reduction of hardness (calcium and magnesium), barium, and radium 226/228, as verified and substantiated by test data. See specifications on [page 14](#) for full list of models.

The Aquasential Smart High Efficiency 1.25 water softeners have been tested and certified by WQA against NSF/ANSI Standard 372, CSA B483.1, and NSF/ANSI Standard 44 for the effective reduction of hardness (calcium and magnesium), barium, and radium 226/228, as verified and substantiated by test data. See specifications on [page 16](#) for full list of models.

The Aquasential Smart High Efficiency Outdoor, Aquasential Smart High Efficiency Twin Outdoor and Aquasential Smart High Efficiency 1.25 Water Softener Controller Enclosures comply with the UL 50/50E standards for an IP46 Rating.

Contains FCC ID: 2AC7Z-ESPWROOM32D and IC: 21098-ESPWROOM32D.

This device complies with part 15 of the FCC Rules subject to the following two conditions:

- (1) This device may not cause harmful interference
- (2) This device must accept all interference received including interference that may cause undesired operation.

Le présent appareil est conforme aux CNR Innovation, Sciences et Développement économique Canada applicables aux appareils radio exempts de licence. L'exploitation est autorisée aux deux conditions suivantes : (1) l'appareil ne doit pas produire de brouillage, et (2) l'utilisateur de l'appareil doit accepter tout brouillage radioélectrique subi, même si le brouillage est susceptible d'en compromettre le fonctionnement.

This device complies with Health Canada's Safety Code. The installer of this device should ensure that RF radiation is not emitted in excess of the Health Canada's requirement.

Cet appareil est conforme avec Santé Canada Code de sécurité 6. Le programme d'installation de cet appareil doit s'assurer que les rayonnements RF n'est pas émis au-delà de l'exigence de Santé Canada.

Changes or modifications not expressly approved by the party responsible for compliance could void the user's authority to operate the equipment.

Les changements ou modifications non expressément approuvés par la partie responsable de la conformité pourraient annuler l'autorité de l'utilisateur à utiliser cet équipement

This equipment has been tested and found to comply with the limits for a Class B digital device, pursuant to part 15 of the FCC Rules. These limits are designed to provide reasonable protection against harmful interference in a residential installation. This equipment generates, uses and can radiate radio frequency energy and, if not installed and used in accordance with the instructions, may cause harmful interference to radio communications. However, there is no guarantee that interference will not occur in a particular installation. If this equipment does cause harmful interference to radio or television reception, which can be determined by turning the equipment off and on, the user is encouraged to try to correct the interference by one or more of the following measures:

Reorient or relocate the receiving antenna.

Increase the separation between the equipment and receiver.

Connect the equipment into an outlet on a circuit different from that to which the receiver is connected.

Consult the dealer or an experienced radio/TV technician for help.

This device complies with Innovation, Science and Economic Development Canada's licence-exempt RSS standard(s). Operation is subject to the following two conditions: (1) this device may not cause interference, and (2) this device must accept any interference, including interference that may cause undesired operation of the device.

Le présent appareil est conforme aux CNR Innovation, Sciences et Développement économique Canada applicables aux appareils radio exempts de licence. L'exploitation est autorisée aux deux conditions suivantes: (1) l'appareil ne doit pas produire de brouillage, et (2) l'utilisateur de l'appareil doit accepter tout brouillage radioélectrique subi, même si le brouillage est susceptible d'en compromettre le fonctionnement.

This Class B digital apparatus complies with Innovation, Science and Economic Development Canada ICES-003.

Cet appareil numérique de la classe B est conforme à la norme NMB-003 du Innovation, Sciences et Développement économique Canada.

Products manufactured and marketed by Culligan International Company (Culligan) and its affiliates are protected by patents issued or pending in the United States and other countries. Culligan reserves the right to change the specifications referred to in this literature at any time, without prior notice. Culligan, Cullar, Filtr-Cleer, Cullneu, AccuSoft, Culligan Man and www.culligan.com are trademarks of Culligan International Company or its affiliates.

Licensed plumbers know that standard industry procedures include only to hand tighten or use strap wrenches on plastic parts. Plastic piping systems must be installed, operated and maintained in accordance with accepted standards and procedures. Not adhering to the recommended service/maintenance can cause damage to equipment or property damage.

Specifications

Culligan Aquasential Smart High Efficiency (HE) Water Conditioners

Culligan Aquasential Smart HE Softener—Downflow Regeneration

Model	9" 9" Outdoor	10" 10" Outdoor	12" 12" Outdoor	14" 14" Outdoor
Control Valve Type	1" Reinforced Thermoplastic with GBX Circuit Board	1" Reinforced Thermoplastic with GBX Circuit Board	1" Reinforced Thermoplastic with GBX Circuit Board	1" Reinforced Thermoplastic with GBX Circuit Board
Installation Environment ¹	Indoor / Outdoor	Indoor / Outdoor	Indoor / Outdoor	Indoor / Outdoor
Overall Conditioner Ht (Softener height w/ control valve)	56 in / 1397 mm	62 in / 1575 mm	60 in / 1524 mm	73 in / 1854 mm
Media Tank Type	Quadra-Hull™	Quadra-Hull™	Quadra-Hull™	Quadra-Hull™
Media Tank Dimensions (Dia x Ht)	9 x 48 in 229 x 1219 mm	10 x 54 in 254 x 1372 mm	12 x 52 in 305 x 1321 mm	14 x 65 in 356 x 1651 mm
Salt Storage Tank Dimensions (Dia x Ht)	11 x 11 in / 160 lb 280 x 280 mm / 73 kg 16 x 43 in / 250 lb 407 x 1093 mm / 113.4 kg 18 x 43 in / 375 lb 458 x 1093 mm / 170 kg	16 x 43 in / 250 lb 407 x 1093 mm / 113.4 kg 18 x 43 in / 375 lb 458 x 1093 mm / 170 kg	18 x 43 in / 375 lb 458 x 1321 mm / 170 kg	24 x 42 in / 650 lb 607 x 1067 mm / 295 kg
Cation Resin, Type and Quantity	Cullex® 8% Resin, 1.0 ft ³ or Cullex® 10% Resin, 1.0 ft ³	Cullex® 8% Resin, 1.5 ft ³	Cullex® 8% Resin, 2.0 ft ³	Cullex® 8% Resin, 3.0 ft ³
Underbedding, Type and Quantity	Cullsan® - 12 lb	Cullsan® - 15 lb	Cullsan® - 20 lb	Cullsan® - 25 lb
Grains Exchange Capacity @ Salt Dosage Per Regeneration ²	19,003 gr @ 4 lb	30,439 gr @ 6 lb	28,365 gr @ 7 lb	42,548 gr @ 10.5 lb
	25,823 gr @ 8 lb	45,609 gr @ 12 lb	44,764 gr @ 16 lb	67,146 gr @ 24 lb
	29,622 gr @ 12 lb	48,623 gr @ 18 lb	58,658 gr @ 24 lb	87,987 gr @ 36 lb
Efficiency at rated dosage ³	4,751 gr/lb @ 4 lb salt dosage	5,073 gr/lb @ 6 lb salt dosage	4,052 gr/lb @ 7 lb salt dosage	4,052 gr/lb @ 10.5 lb salt dosage
Freeboard to Media ⁴	14.5 in / 368 mm	14.5 in / 368 mm	16 in / 406 mm	25 in / 635 mm
Freeboard to Underbedding ⁵	44.5 in / 1130 mm	47.5 in / 1207 mm	46 in / 1168 mm	59 in / 1499 mm
Rated Service Flow @ Pressure Drop	9.0 gpm @ 11 psi 34 Lpm @ 77.2 kPa	9.4 gpm @ 12 psi 35.6 Lpm @ 82.7 kPa	10.0 gpm @ 11 psi 37.9 Lpm @ 75.8 kPa	10.6 gpm @ 11 psi 40.1 Lpm @ 75.8 kPa
Peak Service Flow @ Pressure Drop	10.9 gpm @ 15 psi 41.3 Lpm @ 103.4 kPa	11.0 gpm @ 15 psi 41.6 Lpm @ 103.4 kPa	12.6 gpm @ 15 psi 47.7 Lpm @ 103.4 kPa	12.8 gpm @ 15 psi 48.5 Lpm @ 103.4 kPa
Total Hardness, Maximum	75 gpg	99 gpg	99 gpg	99 gpg
Total Iron, Maximum (dissolved) ⁷	5 ppm	5 ppm	5 ppm	5 ppm
Operating Pressure	20-125 psi / 140–860 kPa	20-125 psi / 140–860 kPa	20-125 psi / 140–860 kPa	20-125 psi / 140–860 kPa
Operating Pressure (Canada)	20-90 psi / 140–620 kPa	20-90 psi / 140–620 kPa	20-90 psi / 140–620 kPa	20-90 psi / 140–620 kPa
Operating Temperature	33-120°F / 1-50°C	33-120°F / 1-50°C	33-120°F / 1-50°C	33-120°F / 1-50°C
Electrical Requirements	28VDC / 60 Hz	28VDC / 60 Hz	28VDC / 60 Hz	28VDC / 60 Hz
Electrical Power Consumption, Min/Max	3 watts / 35 watts	3 watts / 35 watts	3 watts / 35 watts	3 watts / 35 watts
Drain Flow, Maximum ⁶	2.38 gpm / 9 Lpm	2 gpm / 7.57 Lpm	2.86 gpm / 10.56 Lpm	5.28 gpm / 19.99 Lpm
Recharge Time, Average	59 min	77 min	78 min	77 min
Recharge Water Consumption	56 gal / 212 L	82 gal / 310 L	102 gal / 386 L	167 gal / 685 L

¹ Unit must have Outdoor certification/rating label to be used in an Outdoor installation and requires Culligan Outdoor rated power supply.

² Capacities and corresponding salt dosages pertain to low hardness waters. Capacities listed are per regeneration.

³ Efficiency rated according to NSF/ANSI Standard 44.

⁴ Measured from top of resin bed to top surface of tank threads.

⁵ Measured from the top of underbedding to top surface of tank threads.

⁶ Backwash at 120 psi (830 kPa).

⁷ Iron removal claims have not been verified by the Water Quality Association.

Culligan Aquasential Smart HE Softener—Upflow Regeneration

Model	9" Upflow 9" Upflow Outdoor	10" Upflow 10" Upflow Outdoor
Control Valve	1" Reinforced Thermoplastic with HE Circuit Board	1" Reinforced Thermoplastic with HE Circuit Board
Overall Conditioner Height	56 in	62 in
Media Tank Design	Quadra-Hull™	Quadra-Hull™
Media Tank Dimensions (Dia x Ht)	9 x 48 in	10 x 54 in
Salt Storage Tank Dimensions (Dia x Ht)	16" x 43" or 18" x 43"	16" x 43" or 18" x 43"
Exchange Media, Type and Quantity	Cullex® Media, 1.0 ft³	Cullex Media, 1.5 ft³
Underbedding, Type and Quantity	Cullsan® Underbedding, 12 lb	Cullsan Underbedding, 15 lb
Exchange Capacity @ Salt Dosage Per Recharge	10,209 gr @ 2.0 lb	15,314 gr @ 3.0 lb
	16,666 gr @ 4.0 lb	24,999 gr @ 6.0 lb
	25,116 gr @ 8.0 lb	37,674 gr @ 12.0 lb
Efficiency rated dosage ¹	5,105 gr/lb @ 2 lb salt dosage	5,105 gr/lb @ 3 lb salt dosage
Proportional Brining Efficiency Rating ²	5,760 gr/lb @ 2 lb salt dosage	5,898 gr/lb @ 6 lb salt dosage
Freeboard to Media ³	14.5 in	14.5 in
Freeboard to Underbedding ⁴	44.5 in	47.5 in
Salt Storage Capacity	250 lb or 375 lb	250 lb or 375 lb
Rated Service Flow @ Pressure Drop	9.0 gpm @ 11 psi	9.4 gpm @ 12 psi
Auxiliary Flow Rate ⁵	10.8 gpm @ 15 psi	11.0 gpm @ 15 psi
Total Hardness, Maximum	30 gpg	30 gpg
Total Iron, Maximum	2 ppm	2 ppm
Hardness to Iron Ratio, minimum	8 gpg to 1 ppm	8 gpg to 1 ppm
Operating Pressure	20-125 psi (138–862 kPa)	20-125 psi (138–862 kPa)
Operating Pressure (Canada)	20-90 psi (138–621 kPa)	20-90 psi (138–621 kPa)
Operating Temperature	33-120°F (0–49°C)	33-120°F (0–49°C)
Electrical Requirements	28VDC / 60 Hz	28VDC / 60 Hz
Electrical Power Consumption, Min/Max	3 watts / 35 watts	3 watts / 35 watts
Drain Flow, Maximum ⁶	1.98 gpm	1.98 gpm
Recharge Time, Average ⁷ Recharge Water	47 minutes	68 minutes
Consumption, Average ⁷	25 gallons	20 gallons

¹ The efficiency rated dosage is only valid at the stated salt dosage and 2-minute backwash. It is efficiency rated according to NSF/ANSI 44.

² The Proportional Brining Efficiency Rating assumes a 20 percent reserve capacity at the time of regeneration that is typical of what the manufacturer expects under real-world operation. Proportional brining is not measured by NSF/ANSI 44, and so this claim is not, and can not, be rated to NSF/ANSI 44.

³ Measured from top of media to top surface of tank threads. (backwashed and drained).

⁴ Measured from top of underbedding to top surface of tank threads.

⁵ Auxiliary flow rates do not represent the maximum service flow rate used for determining the conditioner's rated capacity and efficiency and that continuous operation at these flow rates greater than the maximum service flow rate may affect capacity and efficiency performances.

⁶ Backwash at 35 psi (830 kPa).

⁷ 2 minute backwash, 2 lb 9" model, 3 lb 10" model.

Culligan Aquasential Smart HE Softener—Municipal

Model	Municipal 9" Municipal 9" Outdoor	Municipal 10" Municipal 10" Outdoor	Municipal 12" Municipal 12" Outdoor	Municipal 14" Municipal 14" Outdoor
Control Valve	1", 5-cycle Reinforced Thermoplastic with Global Electronic (GBE) Circuit Board	1", 5-cycle Reinforced Thermoplastic with Global Electronic (GBE) Circuit Board	1", 5-cycle Reinforced Thermoplastic with Global Electronic (GBE) Circuit Board	1", 5-cycle Reinforced Thermoplastic with Global Electronic (GBE) Circuit Board
Overall Conditioner Height	54 in	60 in	58 in	71 in
Media Tank Design	Quadra-Hull™	Quadra-Hull™	Quadra-Hull™	Quadra-Hull™
Media Tank Dimensions (Dia x Ht)	9 x 48 in	10 x 54 in	12 x 52 in	14 x 65 in
Salt Storage Tank Dimensions (Dia x Ht)	11 x 11 in or 16 x 43 in or 18 x 43 in	16 x 43 in or 18 x 43 in	18 x 43 in	24 x 42 in
Exchange Media, Type and Quantity	Cullex® Media, 0.8 ft ³	Cullex® Media, 1.0 ft ³	Cullex® Media, 1.5 ft ³	Cullex® Media, 2.3 ft ³
Carbon Media, Quantity	6 lb	8 lb	12 lb	18 lb
Underbedding, Type and Quantity	Cullsan® Underbedding, 12 lb	Cullsan® Underbedding, 15 lb	Cullsan® Underbedding, 20 lb	Cullsan® Underbedding, 25 lb
Exchange Capacity @ Salt Dosage Per Recharge	16,789 gr @ 4.0 lb	20,986 gr @ 5.0 lb	28,045 gr @ 7.0 lb	42,943 gr @ 10.7 lb
	22,827 gr @ 8.0 lb	28,534 gr @ 10.0 lb	42,953 gr @ 18.0 lb	54,597 gr @ 18.0 lb
	25,989 gr @ 12.0 lb	32,486 gr @ 15.0 lb	48,620 gr @ 30.0 lb	66,230 gr @ 28.0 lb
Efficiency rated dosage ¹	4,198 gr/lb @ 4 lb salt dosage	4,197 gr/lb @ 5 lb salt dosage	4,006 gr/lb @ 7 lb salt dosage	4,013 gr/lb @ 10.7 lb salt dosage
Chlorine Taste and Odor Capacity	300,000 gallons	339,000 gallons	621,000 gallons	931,500 gallons
Freeboard to Media ²	15.75 in	19.5 in	17.31 in	25.89 in
Freeboard to Underbedding ³	44.5 in	47.5 in	46 in	59 in
Salt Storage Capacity	160 lb or 250 lb or 375 lb	250 lb or 375 lb	375 lb	650 lb
Rated Service Flow @ Pressure Drop	9.0 gpm @ 11 psi	9.4 gpm @ 11 psi	10.0 gpm @ 11 psi	10.6 gpm @ 11 psi
Total Hardness, Maximum	15 gpg	15 gpg	15 gpg	15 gpg
Total Iron, Maximum	0 ppm	0 ppm	0 ppm	0 ppm
Color	Less Than 1	Less Than 1	Less Than 1	Less Than 1
Turbidity	Less Than 5 NTU	Less Than 5 NTU	Less Than 5 NTU	Less Than 5 NTU
TOC	Less Than 0.5 PPM	Less Than 0.5 PPM	Less Than 0.5 PPM	Less Than 0.5 PPM
Operating Pressure	20-125 psi (138–862 kPa)	20-125 psi (138–862 kPa)	20-125 psi (138–862 kPa)	20-125 psi (138–862 kPa)
Operating Pressure (Canada)	20-90 psi (138–621 kPa)	20-90 psi (138–621 kPa)	20-90 psi (138–621 kPa)	20-90 psi (138–621 kPa)
Operating Temperature	33-120°F (0–49°C)	33-120°F (0–49°C)	33-120°F (0–49°C)	33-120°F (0–49°C)
Electrical Requirements	28VDC/60 Hz	28VDC/60 Hz	28VDC/60 Hz	28VDC/60 Hz
Electrical Power Consumption, Min/Max	3 watts / 35 watts	3 watts / 35 watts	3 watts / 35 watts	3 watts / 35 watts
Drain Flow, Maximum ⁴	2.6 gpm	2.6 gpm	3.2 gpm	6.2 gpm
Recharge Time, Average ⁵ Recharge Water	83 min	83 min	68 min	73 min
Consumption, Average ⁵	63 gal	63 gal	98 gal	170 gal

¹The efficiency rated dosage is only valid at the stated salt dosage and is efficiency rated according to NSF/ANSI 44.

²Measured from top of media to top surface of tank threads. (backwashed and drained).

³Measured from top of underbedding to top surface of tank threads.

⁴Backwash at 120 psi (830 kPa).

⁵10 minute backwash, 4 lb 9" model, 5 lb 10" model, 7 lb 12" model, or 10.7 lb 14" model.

Culligan Aquasential Smart HE Softener—Softener-Cleer

Model	9" Softener-Cleer	10" Softener-Cleer	12" Softener-Cleer	14" Softener-Cleer
Control Valve	1" Reinforced Thermoplastic w/ HE Circuit Board	1" Reinforced Thermoplastic w/ HE Circuit Board	1" Reinforced Thermoplastic w/ HE Circuit Board	1" Reinforced Thermoplastic w/ HE Circuit Board
Overall Conditioner Ht	56 in	62 in	60 in	73 in
Media Tank Design	Quadra-Hull™	Quadra-Hull™	Quadra-Hull™	Quadra-Hull™
Media Tank Dimensions (Dia x Ht)	9 x 48 in	10 x 54 in	12 x 52 in	14 x 65 in
Salt Storage Tank Dimensions (Dia x Ht)	16 x 43 in or 18 x 43 in	16 x 43 in or 18 x 43 in	18 x 43 in	24 x 42 in
Exchange Media, Type and Quantity	Cullex® Media, 1.0 ft³	Cullex Media, 1.5 ft³	Cullex Media, 2.0 ft³	Cullex Media, 3.0 ft³
Underbedding, Type and Quantity	Cullsan® Underbedding, 12 lb	Cullsan Underbedding, 15 lb	Cullsan Underbedding, 20 lb	Cullsan Underbedding, 25 lb
Exchange Capacity @ Salt Dosage Per Recharge	19,003 gr @ 4.0 lb	28,391 gr @ 6.0 lb	28,365 gr @ 7.0 lb	42,548 gr @ 10.5 lb
	25,823 gr @ 8.0 lb	43,262 gr @ 12.0 lb	44,764 gr @ 16.0 lb	61,746 gr @ 24 lb
	29,622 gr @ 12.0 lb	48,129 gr @ 18.0 lb	58,658 gr @ 24.0 lb	87,987 gr @ 36 lb
Efficiency rated dosage ¹	4,751 gr/lb @ 4 lb salt dosage	4,732 gr/lb @ 6 lb salt dosage	4,052 gr/lb @ 7 lb salt dosage	4,052 gr/lb @ 10.5 lb salt dosage
Freeboard to Media ²	14.5 in	14.5 in	16 in	25 in
Freeboard to Underbedding ³	44.5 in	47.5 in	46 in	59 in
Salt Storage Capacity	375 lb	375 lb	375 lb	650 lb
Rated Service Flow @ Pressure Drop	9.0 gpm @ 12 psi	9.4 gpm @ 13 psi	10.0 gpm @ 11 psi	10.6 gpm @ 11 psi
Auxiliary Flow Rate ⁴	10.8 gpm @ 15 psi	11.0 gpm @ 15 psi	12.6 gpm @ 15 psi	12.8 gpm @ 15 psi
Total Hardness, Max.	50 gpg	75 gpg	75 gpg	75 gpg
Total Dissolved Iron, Max 10 ppm ⁵	2000 gal	3000 gal	4000 gal	6000 gal
Flow Rate for Iron Reduction ⁶	9.0 gpm	9.4 gpm	10.0 gpm	10.6 gpm
Iron and Sulfur Reducing Bacteria ⁸	Trace Amounts	Trace Amounts	Trace Amounts	Trace Amounts
pH	6.5–8.5	6.5–8.5	6.5–8.5	6.5–8.5
Tannins	0.0 ppm	0.0 ppm	0.0 ppm	0.0 ppm
Total Organic Carbon	0.0 ppm	0.0 ppm	0.0 ppm	0.0 ppm
Free Chlorine Level	0.0 ppm	0.0 ppm	0.0 ppm	0.0 ppm
Dissolved Oxygen	3.0 ppm or below	3.0 ppm or below	3.0 ppm or below	3.0 ppm or below
Polyphosphate	0.0 ppm	0.0 ppm	0.0 ppm	0.0 ppm
Operating Pressure	20-125 psi (138–862 kPa)	20-125 psi (138–862 kPa)	20-125 psi (138–862 kPa)	20-125 psi (138–862 kPa)
Operating Pressure (Canada)	20-90 psi (138–621 kPa)	20-90 psi (138–621 kPa)	20-90 psi (138–621 kPa)	20-90 psi (138–621 kPa)
Operating Temperature	33-120°F (0–49°C)	33-120°F (0–49°C)	33-120°F (0–49°C)	33-120°F (0–49°C)
Electrical Requirements	28VDC/60 Hz	28VDC/60 Hz	28VDC/60 Hz	28VDC/60 Hz
Electrical Power Consumption, Min/Max	3 watts/35 watts	3 watts/35 watts	3 watts/35 watts	3 watts/35 watts
Drain Flow, Maximum ⁶	2.34 gpm	2.5 gpm	3.5 gpm	5.28 gpm
Recharge Time, Average ⁷ Recharge Water	59 minutes	72 minutes	74 minutes	71 minutes
Consumption, Average ⁷	53 gallons	65 gallons	108 gallons	167 gallons

¹ The efficiency rated dosage is only valid at the stated salt dosage and is efficiency rated according to NSF/ANSI 44. Water consumption determined in accordance with 7.1.1 of NSF/ANSI 44.

² Measured from top of media to top surface of tank threads. (backwashed and drained).

³ Measured from top of underbedding to top surface of tank threads.

⁴ Auxiliary flow rates do not represent the maximum service flow rate used for determining the softener's rated capacity and efficiency. Continuous operation at these flow rates greater than the maximum service flow rate might affect capacity and efficiency performances.

⁵ Performance testing on these models was performed at the flow rates specified. When a higher flow rate occurs upon installation, a flow control, restrictor, or other method of flow reduction should be used in order to mimic these performance results.

⁶ Backwash at 120 psi (830 kPa).

⁷ 10 minute backwash, 4 lb 9" model, 6 lb 10" model, 7 lb 10.5" model or 12 lb 14" model salt dosage.

⁸ The Iron and Sulfur reducing bacteria performance is a manufacturer claim and has not been evaluated or certified by WQA.

Culligan Aquasential Smart HE Softener—Softener-Clear Plus

Model	9" Softener-Clear Plus 9" Softener-Clear Plus Outdoor	10" Softener-Clear Plus	12" Softener-Clear Plus	14" Softener-Clear Plus
Control Valve	1" Reinforced Thermoplastic w/ HE Circuit Board			
Overall Conditioner Ht	56 in	62 in	60 in	73 in
Media Tank Design	Quadra-Hull™	Quadra-Hull™	Quadra-Hull™	Quadra-Hull™
Media Tank Dimensions (Dia x Ht)	9 x 48 in	10 x 54 in	12 x 52 in	14 x 65 in
Salt Storage Tank Dimensions (Dia x Ht)	16 x 43 in or 18 x 43 in	16 x 43 in or 18 x 43 in	18 x 43 in	24 x 42 in
Exchange Media, Type and Quantity	Cullex® Media, 1.0 ft³	Cullex Media, 1.5 ft³	Cullex Media, 2.0 ft³	Cullex Media, 3.0 ft³
Underbedding, Type and Quantity	Cullsán® Underbedding, 12 lb	Cullsán Underbedding, 15 lb	Cullsán Underbedding, 20 lb	Cullsán Underbedding, 25 lb
Media, KDF-85	13.5 lb	13.5 lb	27.0 lb	40.5 lb
Exchange Capacity @ Salt Dosage Per Recharge	18,927 gr @ 4.0 lb	28,391 gr @ 6.0 lb	28,365 gr @ 7.0 lb	42,548 gr @ 10.5 lb
	28,841 gr @ 8.0 lb	43,262 gr @ 12.0 lb	44,764 gr @ 16.0 lb	67,146 gr @ 24 lb
	32,086 gr @ 12.0 lb	48,129 gr @ 18.0 lb	58,658 gr @ 24.0 lb	87,987 gr @ 36 lb
Efficiency rated dosage ⁷	4,732 gr/lb @ 4 lb salt dosage	4,732 gr/lb @ 6 lb salt dosage	4,052 gr/lb @ 7 lb salt dosage	4,052 gr/lb @ 10.5 lb salt dosage
Freeboard to Media ²	12 in	12 in	13.5 in	22.5 in
Freeboard to Underbedding ³	44.5 in	47.5 in	46 in	59 in
Salt Storage Capacity	375 lb	375 lb	375 lb	650 lb
Service Flow @ Pressure Drop	8.0 gpm @ 9 psi	9.9 gpm @ 14 psi	8.5 gpm @ 8 psi	11.0 gpm @ 12 psi
Auxiliary Flow Rate ⁸	10.7 gpm @ 15 psi	10.9 gpm @ 15 psi	11.7 gpm @ 15 psi	11.0 gpm @ 15 psi
Total Hardness, Max.	50 gpg	75 gpg	75 gpg	75 gpg
Total Dissolved Iron, Max 10 ppm ⁶	2000 gal	3000 gal	4000 gal	6000 gal
Flow Rate for Iron Reduction ⁶	4 gpm	5.9 gpm	8.5 gpm	11.0 gpm
Hydrogen Sulfide ¹	2 ppm	2 ppm	2 ppm	2 ppm
Iron and Sulfur Reducing Bacteria ¹	Trace Amounts	Trace Amounts	Trace Amounts	Trace Amounts
pH	6.5–8.5	6.5–8.5	6.5–8.5	6.5–8.5
Tannins	0.0 ppm	0.0 ppm	0.0 ppm	0.0 ppm
Total Organic Carbon	0.0 ppm	0.0 ppm	0.0 ppm	0.0 ppm
Free Chlorine Level	0.0 ppm	0.0 ppm	0.0 ppm	0.0 ppm
Dissolved Oxygen	3.0 ppm or below	3.0 ppm or below	3.0 ppm or below	3.0 ppm or below
Polyphosphate	0.0 ppm	0.0 ppm	0.0 ppm	0.0 ppm
Operating Pressure	20-125 psi (138–862 kPa)	20-125 psi (138–862 kPa)	20-125 psi (138–862 kPa)	20-125 psi (138–862 kPa)
Operating Pressure (Canada)	20-90 psi (138–621 kPa)	20-90 psi (138–621 kPa)	20-90 psi (138–621 kPa)	20-90 psi (138–621 kPa)
Operating Temperature	33-120°F (0–49°C)	33-120°F (0–49°C)	33-120°F (0–49°C)	33-120°F (0–49°C)
Electrical Requirements	28VDC/60 Hz	28VDC/60 Hz	28VDC/60 Hz	28VDC/60 Hz
Electrical Power Consumption, Min/Max	3 watts/35 watts	3 watts/35 watts	3 watts/35 watts	3 watts/35 watts
Drain Flow, Maximum ⁴	2.34 gpm	2.5 gpm	3.5 gpm	5.9 gpm
Recharge Time, Average ⁵ Recharge Water	62 minutes	72 minutes	74 minutes	71 minutes
Consumption, Average ⁵	58 gallons	65 gallons	108 gallons	176 gallons

¹ The Hydrogen Sulfide and Iron and Sulfur reducing bacteria performance are manufacturer claims and have not been evaluated or certified by WQA.

² Measured from top of media to top surface of tank threads. (backwashed and drained).

³ Measured from top of underbedding to top surface of tank threads.

⁴ Backwash at 120 psi (830 kPa).

⁵ 10 minute backwash, 4 lb 9" model, 6 lb 10" model, 7 lb 12" model or 10.5 lb 14" model salt dosage.

⁶ Performance testing on these models was performed at the flow rates specified. When a higher flow rate occurs upon installation, a flow control, restrictor, or other method of flow reduction should be used in order to mimic these performance results.

⁷ The efficiency rated dosage is only valid at the stated salt dosage and is efficiency rated according to NSF/ANSI 44.

⁸ Auxiliary flow rates do not represent the maximum service flow rate used for determining the softener's rated capacity and efficiency. Continuous operation at these flow rates greater than the maximum service flow rate might affect capacity and efficiency performances.

Culligan Aquasential Smart HE—Twin Water Conditioners—Downflow Regeneration

Model	Twin 9" Twin 9" Outdoor	Twin 10" Twin 10" Outdoor	Twin 12" Twin 12" Outdoor	Twin 14" Twin 14" Outdoor
Control Valve	1" Reinforced Thermoplastic w/ HE Circuit Boards			
Overall Conditioner Ht	56 in	62 in	60 in	73 in
Media Tank Design	Quadra-Hull™	Quadra-Hull™	Quadra-Hull™	Quadra-Hull™
Media Tank Dimensions (Dia x Ht)	9 x 48 in	10 x 54 in	12 x 52 in	14 x 65 in
Salt Storage Tank Dimensions (Dia x Ht)	18 x 43 in	18 x 43 in	18 x 43 in	24 x 42 in
Exchange Media, Type and Quantity	Cullex® Media, 1.0 ft³	Cullex Media, 1.5 ft³	Cullex Media, 2.0 ft³	Cullex Media, 3.0 ft³
Underbedding, Type and Quantity	Cullsan® Underbedding, 12 lb	Cullsan Underbedding, 15 lb	Cullsan Underbedding, 20 lb	Cullsan Underbedding, 25 lb
Exchange Capacity @ Salt Dosage Per Recharge (per tank)	19,003 gr @ 4.0 lb	30,439 gr @ 6.0 lb	28,365 gr @ 7.0 lb	42,548 gr @ 10.5 lb
	25,823 gr @ 8.0 lb	45,609 gr @ 12.0 lb	44,764 gr @ 16.0 lb	67,146 gr @ 24 lb
	29,622 gr @ 12.0 lb	48,623 gr @ 18.0 lb	58,658 gr @ 24.0 lb	87,987 gr @ 36 lb
Efficiency rated dosage¹ (per tank)	4,751 gr/lb @ 4 lb salt dosage	5,073 gr/lb @ 6 lb salt dosage	4,052 gr/lb @ 7 lb salt dosage	4,052 gr/lb @ 10.5 lb salt dosage
Freeboard to Media²	14.5 in	14.5 in	16 in	25 in
Freeboard to Underbedding³	44.5 in	47.5 in	46 in	59 in
Salt Storage Capacity	375 lb	375 lb	375 lb	650 lb
Rated Service Flow @ Pressure Drop	9.0 gpm @ 11 psi	9.4 gpm @ 12 psi	10.0 gpm @ 11 psi	10.6 gpm @ 11 psi
Auxiliary Flow Rate⁴	10.8 gpm @ 15 psi	11.0 gpm @ 15 psi	12.6 gpm @ 15 psi	12.8 gpm @ 15 psi
Total Hardness, Maximum	75 gpg	99 gpg	99 gpg	99 gpg
Total Iron, Maximum	5 ppm	5 ppm	5 ppm	5 ppm
Hardness to Iron Ratio, Minimum	8 gpg to 1 ppm	8 gpg to 1 ppm	8 gpg to 1 ppm	8 gpg to 1 ppm
Operating Pressure	20-125 psi (138–862 kPa)	20-125 psi (138–862 kPa)	20-125 psi (138–862 kPa)	20-125 psi (138–862 kPa)
Operating Pressure (Canada)	20-90 psi (138–621 kPa)	20-90 psi (138–621 kPa)	20-90 psi (138–621 kPa)	20-90 psi (138–621 kPa)
Operating Temperature	33-120°F (0–49°C)	33-120°F (0–49°C)	33-120°F (0–49°C)	33-120°F (0–49°C)
Electrical Requirements	28VDC/60 Hz	28VDC/60 Hz	28VDC/60 Hz	28VDC/60 Hz
Electrical Power Consumption, Min/Max	3 watts/35 watts	3 watts/35 watts	3 watts/35 watts	3 watts/35 watts
Drain Flow, Maximum⁵	1.98 gpm	2 gpm	2.86 gpm	5.28 gpm
Recharge Time, Average⁶ Recharge Water	59 minutes	77 minutes	78 minutes	77 minutes
Consumption, Average⁶	46 gallons	82 gallons	102 gallons	181 gallons

¹ The efficiency rated dosage is only valid at the stated salt dosage and is efficiency rated according to NSF/ANSI Standard 44.

² Measured from top of media to top surface of tank threads (backwashed and drained).

³ Measured from top of underbedding to top surface of tank threads.

⁴ Auxiliary flow rates do not represent the maximum service flow rate used for determining the softener's rated capacity and efficiency and that continuous operation at these flow rates greater than the maximum service flow rate may affect capacity and efficiency performances.

⁵ Backwash at 120 psi.

⁶ 10 minute backwash, 4 lb 9" model, 6 lb 10" model, 7 lb 12" model, or 10.5 lb 14" model salt dosage.

Culligan Aquasential Smart HE—Twin Softener—Upflow Regeneration

Model	Twin Upflow 9"	Twin Upflow 10"
Control Valve	1" Reinforced Thermoplastic with HE Circuit Board	
Overall Conditioner Height	56 in	62 in
Media Tank Design	Quadra-Hull™	
Media Tank Dimensions (Dia x Ht)	9 x 48 in	10 x 54 in
Salt Storage Tank Dimensions (Dia x Ht)	18 x 43 in	18 x 43 in
Exchange Media, Type and Quantity	Cullex® Media, 1.0 ft³	Cullex Media, 1.5 ft³
Underbedding, Type and Quantity	Cullsans® Underbedding, 12 lb	Cullsans Underbedding, 15 lb
Exchange Capacity @ Salt Dosage Per Recharge (per tank)	10,209 gr @ 2.0 lb	15,314 gr @ 3.0 lb
	16,666 gr @ 4.0 lb	24,999 gr @ 6.0 lb
	25,116 gr @ 8.0 lb	37,674 gr @ 12.0 lb
Efficiency Rated Dosage (per tank) ¹	5,105 gr/lb @ 2 lb salt dosage	5,105 gr/lb @ 3 lb salt dosage
Proportional Brining Efficiency Rating (per tank) ²	5,760 gr/lb @ 2 lb salt dosage	5,898 gr/lb @ 6 lb salt dosage
Freeboard to Media ³	14.5 in	14.5 in
Freeboard to Underbedding ⁴	44.5 in	47.5 in
Salt Storage Capacity	375 lb	375 lb
Rated Service Flow @ Pressure Drop	9.0 gpm @ 15 psi	9.1 gpm @ 15 psi
Auxiliary Flow Rate ⁵	10.8 gpm @ 15 psi	11.0 gpm @ 15 psi
Total Hardness, Maximum	30 gpg	30 gpg
Total Iron, Maximum	2 ppm	2 ppm
Hardness to Iron Ratio, Minimum	8 gpg to 1 ppm	8 gpg to 1 ppm
Operating Pressure	20-125 psi (138–862 kPa)	20-125 psi (138–862 kPa)
Operating Pressure (Canada)	20-90 psi (138–621 kPa)	20-90 psi (138–621 kPa)
Operating Temperature	33-120°F (0–49°C)	33-120°F (0–49°C)
Electrical Requirements	28VDC/60 Hz	28VDC/60 Hz
Electrical Power Consumption, Min/Max	3 watts/35 watts	3 watts/35 watts
Drain Flow, Maximum ⁶	1.98 gpm	1.98 gpm
Recharge Time, Average ⁸ Recharge Water	47 minutes	68 minutes
Consumption, Average ⁷ (Evaluated by WQA)	33 gallons	35 gallons
Consumption, Average ⁸	25 gallons	30 gallons

¹ The efficiency rated dosage is only valid at the stated salt dosage and 2-minute backwash. It is efficiency rated according to NSF/ANSI 44.

² The Proportional Brining Efficiency Rating assumes a 20 percent reserve capacity at the time of regeneration that is typical of what the manufacturer expects under real-world operation. Proportional brining is not measured by NSF/ANSI 44, and so this claim is not, and can not, be rated to NSF/ANSI 44.

³ Measured from top of media to top surface of tank threads. (backwashed and drained).

⁴ Measured from top of underbedding to top surface of tank threads.

⁵ Auxiliary flow rates do not represent the maximum service flow rate used for determining the softener's rated capacity and efficiency and that continuous operation at these flow rates greater than the maximum service flow rate may affect capacity and efficiency performances.

⁶ Backwash at 120 psi (830 kPa).

⁷ Connected the first water consumption line..

⁸ 2-minute backwash, 2 lb 9" model, 3 lb 10" model salt dosage.

THIS PAGE INTENTIONALLY LEFT BLANK

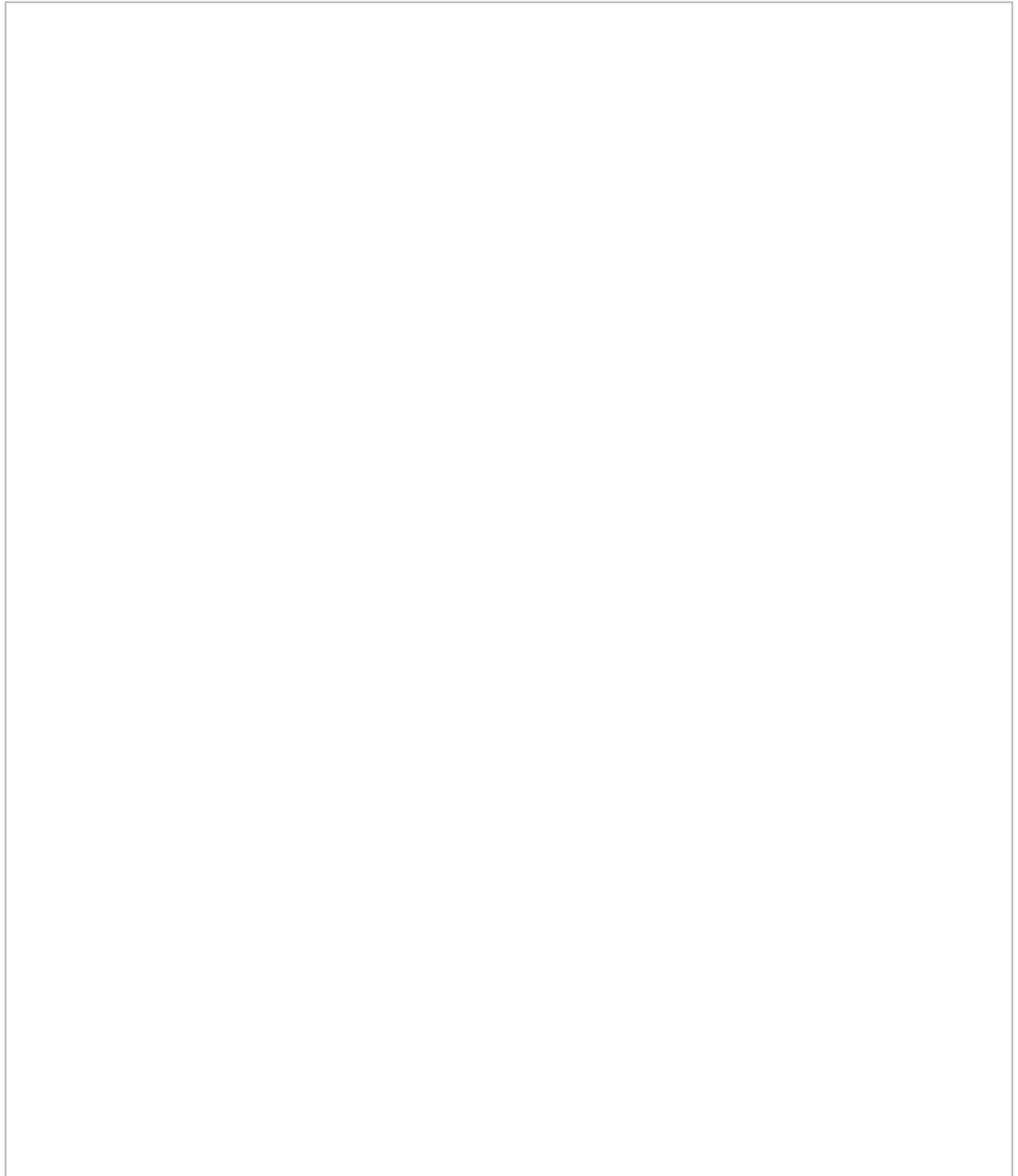

Culligan Aquasential Smart HE Softener—1.25”

Model	HE-1.25-10	HE-1.25-12	HE-1.25-14	HE-1.25-16
Control Valve	1¼" Reinforced Thermoplastic with GBE Circuit Board			
Overall Conditioner Height	62 in	60 in	73 in	73 in
Media Tank Design	Quadra-Hull™	Quadra-Hull™	Quadra-Hull™	Quadra-Hull™
Media Tank Dimensions (Dia x Ht)	10 x 54 in	12 x 52 in	14 x 65 in	16 x 65 in
Salt Storage Tank Dimensions (Dia x Ht)	18 x 43 in	18 x 43 in	24 x 40 in	24 x 40 in
Exchange Media, Type and Quantity	Cullex® Media, 1.5 ft ³	Cullex® Media, 2.0 ft ³	Cullex® Media, 3.0 ft ³	Cullex® Media, 4.0 ft ³
Underbedding, Type and Quantity	Cullsan® Underbedding, 15 lb	Cullsan® Underbedding, 20 lb	Cullsan® Underbedding, 30 lb	Cullsan® Underbedding, 40 lb
Exchange Capacity @ Salt Dosage Per Recharge	29,764 gr @ 6.0 lb 43,505 gr @ 12.0 lb 51,353 gr @ 18.0 lb	35,027 gr @ 8.0 lb 52,874 gr @ 16.0 lb 61,235 gr @ 24.0 lb	52,541 gr @ 12.0 lb 79,311 gr @ 24.0 lb 91,853 gr @ 36.0 lb	70,054 gr @ 16.0 lb 105,748 gr @ 32.0 lb 122,470 gr @ 48.0 lb
Efficiency Rated Dosage ¹	4,961 gr/lb @ 6 lb salt dosage	4,378 gr/lb @ 8 lb salt dosage	4,378 gr/lb @ 12 lb salt dosage	4,378 gr/lb @ 16 lb salt dosage
Freeboard to Media ²	14.5 in	16 in	25 in	25 in
Freeboard to Underbedding ³	47.5 in	46 in	59 in	59 in
Salt Storage Capacity	375 lb	375 lb	650 lb	650 lb
Rated Service Flow @ Pressure Drop	14.9 gpm @ 14 psi	17.9 gpm @ 15 psi	19.3 gpm @ 15 psi	21.0 gpm @ 15 psi
Total Hardness, Maximum	99 gpg	99 gpg	99 gpg	99 gpg
Total Iron, Maximum	5 ppm	5 ppm	5 ppm	5 ppm
Hardness to Iron Ratio, Minimum	8 gpg to 1 ppm	8 gpg to 1 ppm	8 gpg to 1 ppm	8 gpg to 1 ppm
Operating Pressure	20-125 psi	20-125 psi	20-125 psi	20-125 psi
Operating Pressure (Canada)	20-90 psi	20-90 psi	20-90 psi	20-90 psi
Operating Temperature	33-120°F	33-120°F	33-120°F	33-120°F
Electrical Requirements	28VDC/60Hz	28VDC/60Hz	28VDC/60Hz	28VDC/60Hz
Electrical Power Consumption, Min/Max	3 watts/35 watts	3 watts/35 watts	3 watts/35 watts	3 watts/35 watts
Drain Flow, Maximum ⁴	2.38 gpm	3.88 gpm	5.5 gpm	5.5 gpm
Recharge Time, Average ⁵	155 min	124 min	113 min	117 min
Recharge Water Consumption, Average ⁵	82 gal	121 gal	184 gal	250 gal

¹The efficiency rated dosage is only valid at the stated salt dosage and is efficiency rated according to NSF/ANSI 44.

²Measured from top of media to top surface of tank threads. (backwashed and drained).

³Measured from top of underbedding to top surface of tank threads.

⁴Backwash at 120 psi (830 kPa).

⁵10 minute backwash, 6 lb 10" model, 8 lb 12" model, 12 lb 14" model or 16 lb 16" model salt dosage.

Application & Operation

It's All So Easy, So Economical, So Efficient, So Enjoyable!

Kind To Skin And Complexion

Soft water will help prevent red, itchy or dry skin because there are no hardness impurities to cause soreness, no soap scum to coat the skin. Shaving is easier, smoother—either with a blade or electric shaver.

Bathing And Showering

You'll use far less soap with conditioned water. Use your soap very sparingly—not as you did before soft water. Just a quick rinse removes all lather, leaving your skin pleasantly smooth and silky because now it's free of sticky soap curd and film.

Saves Washing Costs. Helps Control Environmental Pollution

Soft water washes whiter and cleaner with less soap or detergent. Because the hardness impurities are removed, your soap can concentrate solely on washing. People usually find that they can reduce the amount of soap they use substantially. If you normally use a cup per wash load with hard water, try using 1/3 cup depending on the size of your wash load and the degree of soil. Different amounts are required, but you can use less with softened water. An added bonus is the fact that your washable fabrics will last longer.

Super Hair Conditioning

Soft water is great for scalp and hair care. No insoluble deposits are formed. Hair is shinier, softer, more manageable. Reduce the amount of shampoo you have normally used.

Dishes Are A Delight

Washed by hand or in a dishwasher, glassware, dishes, and silver wash cleaner and easier. Follow your dishwasher manufacturer's instructions. Soft water promotes sanitation because no greasy hard water film can form to collect or harbor bacteria.

Easier Housekeeping, Gleaming Fixtures

You'll be amazed at the marvelous difference. Just a swish of the cloth, and the bathtub or shower and fixtures are clean and sparkling. Imagine, no scouring! No hard water scum to cause rings, streaks, spots, and stains. To keep their gleaming luster, simply wipe fixtures with a towel after use. Formica, tile, walls, floors, woodwork surfaces clean easier, stay clean longer. You'll save on cleaning aids and save on time.

Saves Water-Heating Energy, Helps Water-Using Appliances

Soft water reduces the formation of rock-like hard water scale that encrusts water heaters, hot water pipes, shower heads, and water-using appliances. This scale can cause premature maintenance and failure.

Elimination of hard water also provides substantial energy savings because scale acts as an insulator, wasting electricity or gas used to heat water.

Water For Lawns And Household Plants

If possible, lawn sprinkling faucets should be supplied with hard water primarily because it is not economical to soften so much water.

Household plants are much more sensitive than lawns with respect to the kind of water which is best. First, because they receive no rainfall and, second, there is little or no drainage of the soil. Preferably they should be watered with rainwater or water which is low in mineral content such as distilled or demineralized water. Softened water is not recommended for house plants because a build-up of sodium in the soil may interfere with efficient absorption of water by the plant root system. Additional information may be obtained from your independently operated Culligan dealer.

Culligan Municipal Softener

With the Culligan Municipal softener you will experience the above benefits in addition to the reduction of chlorine taste and odor for a fresh, clean taste and smell.

Why Water Gets Hard And How It Is Softened

All of the fresh water in the world originally falls as rain, snow, or sleet. Surface water is drawn upward by the sun, forming clouds. Then, nearly pure and soft as it starts to fall, it begins to collect impurities as it passes through smog and dust-laden atmosphere. And as it seeps through soil and rocks it gathers hardness, rust, acid, unpleasant tastes and odors.

Water hardness is caused primarily by limestone dissolved from the earth by rainwater. Because of this, in earlier times people who wanted soft water collected rainwater from roofs in rain barrels and cisterns before it picked up hardness from the earth.

Some localities have corrosive water. A softener cannot correct this problem and so its written warranty disclaims liability for corrosion of plumbing lines, fixtures or appliances. If you suspect corrosion, your Culligan dealer has equipment to control the problem.

Iron is a common water problem. The chemical/physical nature of iron found in natural water supplies is exhibited in four general types:

1. **Dissolved Iron—**
Also called ferrous or “clear water” iron. This type of iron can be removed from the water by the same ion exchange principle that removes the hardness elements, calcium and magnesium. Dissolved iron is soluble in water and is detected by taking a sample of the water to be treated in a clear glass. The water in the glass is initially clear, but on standing exposed to the air, it may gradually turn cloudy or colored as it oxidizes.
2. **Particulate Iron—**
Also called ferric or colloidal iron. This type of iron is an undissolved particle of iron. A softener will remove larger particles, but they may not be washed out in regeneration effectively and will eventually foul the ion exchange resin. A filtering treatment will be required to remove this type of iron.
3. **Organic Bound Iron—**
This type of iron is strongly attached to an organic compound in the water. The ion exchange process alone cannot break this attachment and the softener will not remove this type of iron.
4. **Bacterial Iron—**
This type of iron is protected inside a bacteria cell. Like the organic bound iron, it is not removed by a water softener.

When using a softener to remove both hardness and dissolved iron it is important that it regenerates more frequently than ordinarily would be calculated for hardness removal alone. Although many factors and formulas have been used to determine this frequency, it is recommended that the softener be regenerated when it has reached 50–75% of the calculated hardness alone capacity. This will minimize the potential for bed fouling. (Iron removal claims have not been verified by the Water Quality Association, except for Smart HE Softener-Cleer and Softener-Cleer Plus models.)

If you are operating a water softener on clear water iron, regular resin bed cleaning is needed to keep the bed from coating with iron. Even when operating a softener on water with less than the maximum of dissolved iron, regular cleaning should be performed. Clean every six months or more often if iron appears in your conditioned water supply. Use resin bed cleaning compounds carefully following the directions on the container.

NOTE! Do not use where the water is microbiologically unsafe or with water of unknown quality without adequate disinfection before or after the unit.

The Culligan Process

Your Culligan water conditioner consists of three basic components, (A) the Control Valve, (B) the Mineral Tank, and (C) the Brine System.

A. Control Valve

The exclusive Culligan control valve automatically performs a variety of tasks that are necessary for the proper operation of your water conditioner. These tasks, commonly referred to as cycles or operating positions, are **Service**, **Regeneration**, and **Brine Refill**.

1. **Service:** While the control valve is in the service cycle, hard water is directed down through the column of Cullex® resin where hardness minerals are removed from the water. The softened water is then directed into your household plumbing lines. The ability of the Cullex resin to remove hardness minerals needs to be periodically replenished; this is referred to as Regeneration.
2. **Regeneration:** While the control valve is in the regeneration cycle, water is first directed up through the column of Cullex resin to flush accumulated sediment out of the resin and down the drain. Then, the regenerant brine solution is slowly drawn from the bottom of the salt storage tank of the Brine System and is directed down through the column of Cullex resin, restoring the ability of the resin to remove hardness minerals from your water supply. Once completed, the regeneration cycle is followed by Brine Refill.
3. **Brine Refill:** While the control valve is in the brine refill cycle, a predetermined amount of water is directed to the salt storage tank of the Brine System so that additional salt can be dissolved to provide the brine solution that will be needed for the next regeneration cycle.



B. The Mineral Tank

The Mineral Tank contains the Cullex resin column, Cullsant[®] underbedding, and an outlet manifold (the Culligan Municipal also includes carbon media for chlorine taste & odor reduction). The number of gallons of hard water that can be softened by the Cullex resin column before it needs regeneration is called the “capacity” of the resin column, and depends upon the amount of hardness minerals in each gallon of water (expressed as grains per gallon) and upon the amount of regenerant brine solution (expressed as pounds of salt) passed through the resin column during regeneration.

Your Culligan service person, taking into account the hardness of your water and the amount of softened water your household may reasonably expect to use each day, has carefully established how often the softener will regenerate and how much salt will be used for each regeneration. This will ensure that all of your soft water needs will be fulfilled without using an excessive amount of salt.

C. The Brine System

The Brine System consists of a salt storage container and hydraulic Dubl-Safe™ valve. The salt storage container holds the salt that is used to make the regenerant brine solution. The hydraulic Dubl-Safe valve limits the amount of water that is returned to the salt storage tank during the brine refill cycle.

Because a predetermined amount of salt is dissolved with each brine refill cycle, the salt must be periodically replenished in order to maintain efficient operation. Your Culligan service person will be able to tell you about how often salt must be added to the salt storage container.

Modes of Operation

Water Meter Mode

In water meter mode, the controller keeps track of the quantity of water that has flowed through the resin bed. Based on the influent water hardness and the hardness capacity of the resin bed, a service life expectancy in the quantity of softened water is calculated and programmed into the control. When the set point is reached, regeneration is triggered. If the predict mode is not selected the regeneration will start at time of regeneration. In immediate mode the regeneration starts as soon as the regeneration signal is provided. If time clock backup is set and the capacity has not been exhausted but the days since last regen is greater than time clock backup, setting the softener will immediately regenerate.

Aqua-Sensor® Mode

The Aqua-Sensor is a conductivity probe that senses when the hardness front passes through the resin bed. It functions independently of the influent water hardness so therefore, is useful in conditions when the influent water hardness varies throughout the year. It provides for the most efficient mode of operation. In addition to sensing when a resin bed is exhausted, it can also be used to determine when the brine solution is rinsed from the resin bed during the Brine Draw/Slow Rinse cycle triggering the control to move to fast rinse. This patented feature provides water savings by optimizing the amount of rinse water required to completely rinse out the resin bed.

Predict Mode

The Predict Mode is used with the flow meter to determine the optimum regeneration point. Before the regeneration starts, the control will compare the remaining capacity value with the average daily water use. If the average daily water usage is less than the reserve capacity, the controller will wait 24 more hours before regeneration. If the reserve capacity is less than the average daily water usage, the control will initiate regeneration. This works in delay mode only. At any time, if the total capacity value is reached, the control will initiate an immediate regeneration.

Pre-Rinse Mode

The Pre-rinse mode is used to pre-rinse the softener resin bed or filter media. The pre-rinse in flow meter mode will occur after the control has sensed that no water has flowed through the control for a period of X hours (can be set through the programming menu). When the control is in this mode, once the X amount of hours have elapsed the control will cycle to the fast rinse position for the pre-set length of minutes and then return to the home or service position.

Down Flow Regeneration

Water and regenerate flow downward through the media tank.

Up Flow Regeneration

Water flow is downward and regenerate flow is upward through the media tank. The significance of this is that regeneration will be most effective in those parts of the resin bed which are treated with the freshest regenerate solution. There will tend to be less hardness leakage with up-flow regeneration.

Proportional Brining

The control monitors your softened water usage making only enough brine to regenerate that part of the resin bed that has been exhausted. In this way the amount of salt used relates directly to the amount of softened water used, making it more efficient and cost effective. Proportional brining can only be used with upflow regeneration. The Aqua-Sensor or meter can be used to initiate a regeneration.



Dial-A-Softness®

Dial-A-Softness is a manual adjustment built into the control valve that allows for variable hardness bypass into the softened water. The hard water bypass can be adjusted from 0% to 30%. The Dial-A-Softness also increases the softener capacity in proportion to the percent hard water bypass (less salt used).

Culligan Connect™

The Culligan Connect™ interface is an intuitive mobile app and is available on both iOS and Android. Users will see their daily and weekly usage patterns graphically represented and instantly updated each time they open the app. In addition, low salt alerts and the ability to put the unit in bypass mode or regeneration from anywhere offer an all new level of control and convenience.

Manual Regeneration

Manual regeneration can be initiated via the softener control valve or wireless remote display. Manual regeneration can be initiated to begin regeneration immediately or that night. To immediately initiate regeneration, press and hold  for at least ten (10) seconds. To cancel a delayed regeneration, press and hold  for at least five (5) seconds.

Salt Supply

Salt is the mineral used to regenerate your water conditioner. A brine solution is automatically made up in the bottom of the salt storage container, the Cullex® resin beads in the mineral tank are flushed with the brine solution as a step in the regenerating process.

Your Culligan Water Conditioner has been carefully designed to get the greatest amount of softening capacity from the salt it uses. Here is some pertinent information about salt usage, types and service.

Salt Economizer

This control is set at the time of installation, and determines salt usage according to the water hardness, number of persons in the household, and water usage.

What Kind of Salt is Best

All Culligan Water Conditioners are designed to use any water conditioner salt of good quality, including rock, pellet, solar, or “evaporated” types.

All rock salt, regardless of source, contains insoluble material which collects at the bottom of the salt storage tank and requires periodic clean-out.

If purified salt products are used, the salt storage compartment will require less frequent clean-out, but you must check more frequently for “bridging.”

Regardless of what type of salt is used, we recommend Culligan Brand Salt as suggested by your Culligan Dealer. He or she is the expert and can provide you with the best product for your Culligan Water Conditioner.

Automatic Salt Delivery Service

Ask your Culligan Dealer for details about salt delivery service. You can have your salt supply replenished on a regular basis. Whether you have automatic delivery service or pick up salt from your Culligan Dealer, you will be getting quality salt packaged according to rigid Culligan specifications. Using Culligan Brand Salt will help assure continued efficiency and trouble-free operation of your water conditioner.

The modem allows for the system to be remotely monitored, detecting problems before they occur, to schedule salt delivery when it is needed and to keep the system software up to date with the latest advances.

NOTE! Sodium Information: Water softeners using sodium chloride for regeneration add sodium to the water. Those on sodium restricted diets should consider the added sodium as part of their overall sodium intake.

Care & Cleaning

Following these simple precautions will help assure continued trouble-free service and keep your Culligan Water Conditioner looking like new for years.

- Do not place heavy objects on top of the salt storage tank or timer cover.
- Use only mild soap and warm water when cleaning the exterior of the conditioner. Never use harsh, abrasive cleaning compounds or those which contain acid, such as vinegar, bleach and similar products.
- Important: Protect your water conditioner and the entire drainline from freezing temperatures.



WARNING!

If your unit should freeze, do not attempt to disassemble it. Call your Culligan Dealer.

- Important: Culligan water softeners are sold for use on potable water only. If at any time the water becomes contaminated, such as during a “boil water” advisory, the operation of the water softener should be discontinued until it is verified that the water is again potable. To do this, turn the blue knob in a clockwise position, then call your Culligan dealer to have your system sanitized before it is placed back into service.
- Should service, adjustment or trouble-shooting information be needed which is not covered in the Use and Care Guide, call your Culligan Dealer.

For parts and service availability please call your local independently operated Culligan dealer. For your nearest Culligan dealer, call (800) 285-5442.

Cleaning Out the Salt Storage Tank

A periodic clean-out of the Salt Storage Tank is necessary to keep your Culligan Water Conditioner at peak operating efficiency. Do it at least every two years when the salt supply is low. Follow these step-by-step procedures:

Tools Needed

- Scoop
- Clean, bucket-size container
- Garden hose
- Household scrub brush or sponge

Procedure

1. Remove the salt storage tank cover and the cap from the brine valve chamber.
2. Disconnect the brine line from the brine valve by holding the outer ring of the push fitting; push the tubing in slightly before pulling it out.
3. Lift the brine valve out of the brine valve chamber and set aside in an upright position.
4. If you'd like to save any clean, dry salt remaining in the tank, remove it and place it in a clean container.
5. Using the scoop, dig out and discard as much remaining salt, water and debris as possible.
6. Remove the brine valve chamber by removing the screws on either side of the salt tank.
7. Remove the salt plate at the bottom of the brine tank.
8. Lay the salt tank on its side and direct a brisk stream of water from your garden hose to its inside to rinse out all residue.
9. Using a household scrub brush and a mild soapy solution, clean the salt plate. This will complete the tank cleaning.
10. Insert the brine valve into the chamber and replace brine valve chamber cap. (Re-insert the brine valve into the chamber, re-insert the brine line fully, and replace brine valve chamber cap.)
11. Fill the salt storage tank with 4 to 6 inches of water.
12. Fill the tank with salt to within a few inches of the top.
13. Replace salt storage tank cover.

If tastes and odors return frequently, even after sanitization, a continuous chlorination system may be needed. Contact your local Culligan dealer for water bacterial analysis.

Sanitizing

A water softener in daily use on a potable water supply generally requires no special attention other than keeping the salt tank filled. Occasionally, however, a unit may require sanitization under one of the following conditions:

- At start-up time.
- After standing idle for a week or more.
- On private supplies, the appearance of off-tastes and odors, particularly if musty or “rotten egg” (caused by harmless sulfate-reducing bacteria).

NOTE! If the water supply contains iron, regenerate the softener before sanitizing to remove iron from the resin.



CAUTION!

Hazard from toxic fumes! Chlorine bleach and common iron control chemicals may generate toxic fumes when mixed.

CAUTION!

Do not use this procedure if the softener salt contains iron control additives.

If the unit uses any compounds containing sodium hydrosulfite, sodium bisulfite, or any other reducing agent, disconnect the device feeding the chemical(s) and manually regenerate the unit before sanitizing.

Do not use this procedure if the softener salt contains iron control additives.

1. Remove the brine tank cover.
2. Pour directly into the brine chamber 1/3 to 1/2 cup of unscented 6% household bleach for each cubic foot of resin in the tank.
3. Manually start recharge. Allow the unit to complete the recharge cycle automatically.

If tastes and odors return frequently, even after sanitization, a continuous chlorination system may be needed. Contact your local Culligan dealer for water bacterial analysis. See [page 2](#) for more information..

Menu Navigation

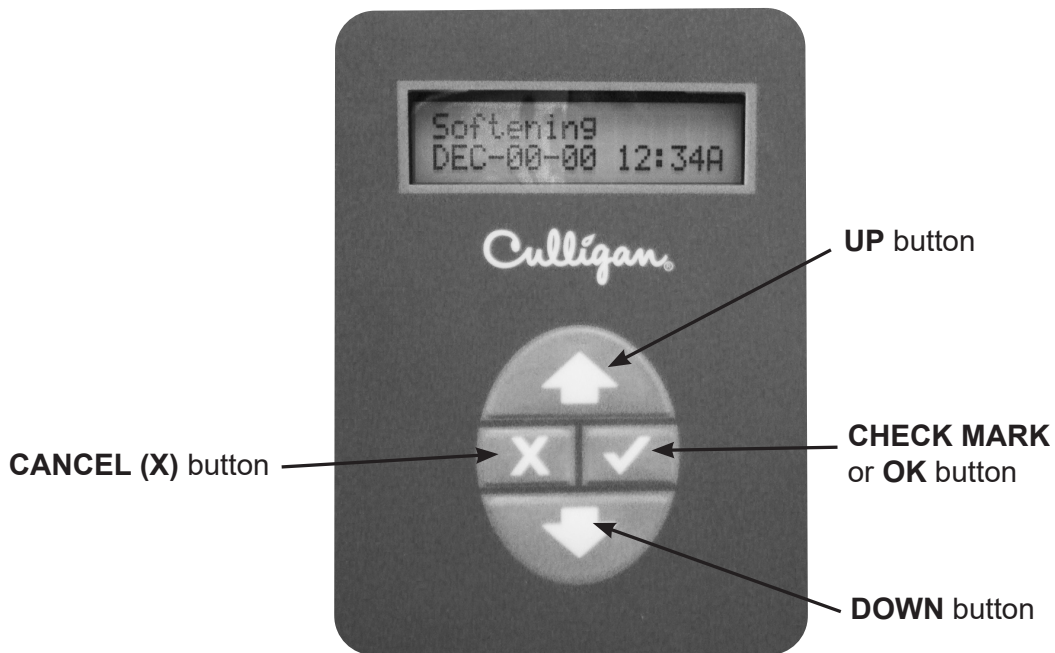

UP ARROW button: scrolls up the menu





DOWN ARROW button: scrolls down the menu



CHECK MARK button: selects the highlighted option, opens a new screen, or accepts a changed setting



CANCEL or **X** button: returns to the previous screen or cancels a changed setting

NOTE! Hold down  or  to quickly scroll through the setting without repeatedly pressing the button.

NOTE! The control must be returned to the HOME screen if settings are changed.

Use the Culligan Connect™ app to update the date or time.



Regeneration

REGEN Tonite when the control has signaled for a regeneration. Regenerating is displayed while the control is in regeneration. The following are conditions that will call for regeneration:

1. When the Soft-Minder® meter has recorded the passage of a predetermined number of gallons.
2. When the Aqua-Sensor® Probe senses the hardness in the Cullex Media.
3. At the preset time, when the number of days without a regeneration is equal to the regeneration interval (timeclock backup) setting.
4. At the preset time, when Regen Tonite is selected. The screen displays Regen Tonite.
5. Immediately, when the Regen Now is selected. The screen displays Regenerating.
6. Immediately, if power to the unit has been off for more than three hours and the time of day has been restored.
7. At the preset time based on “Day-of-Week” Regeneration setting.

Use the Culligan Connect™ app or follow any of the procedures that follow to initiate a manual regeneration.

Delayed Regeneration

Screen Display	Range	Setting Description
SOFTENING JAN-01-18 12:01P	N/A	1. From the HOME screen, press  and hold for at least three (3)seconds and then release the button.
	Regen Tonite	2. The screen displays the regeneration status on the first line of the display. The system will regenerate at a scheduled time.
	Regen Off	3. To cancel a delayed regeneration, press  and hold for at least three (3) seconds and then release the button. The screen displays the new status.

Immediate Regeneration

Screen Display	Range	Setting Description
	N/A	1. From the HOME screen, press  and hold for at least ten (10) seconds.
	Regen Now	2. The screen displays the regeneration status on the first line of the display. The softener will initiate an immediate regeneration.
	N/A	3. The first line of the screen displays REGENERATING .

When & How to Bypass Your System

Normally, all water except outside lines passes through the water softener. There are times when the water softener should be bypassed, using the Cul-Flo-Valv® Bypass, or a three-way bypass valve. You should bypass:

1. If lines to outside faucets do not bypass the water softener, and you do not want to waste softened water on lawn sprinkling or other outside uses.
2. If you are going away on vacation and do not want the unit to recharge.

Bypass Valve

In the back of Culligan water softener is a Cul-Flo-Valv® Bypass valve. To bypass the unit, turn the blue knob clockwise. To return to softened water service, turn the blue knob counter-clockwise.

Figure 1. Bypass valve

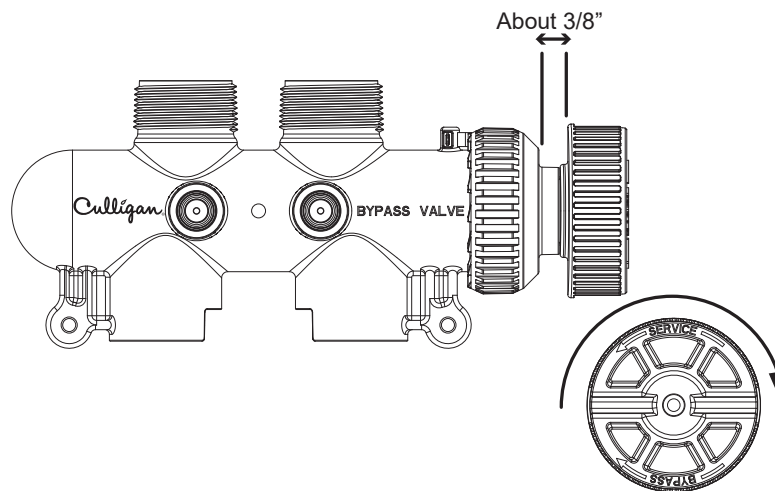

Bypassed

To BYPASS, turn the blue knob clockwise (see directional arrow on end of knob) until the knob stops as shown in [Figure 1](#). DO NOT OVERTIGHTEN!

Figure 2. Service valve

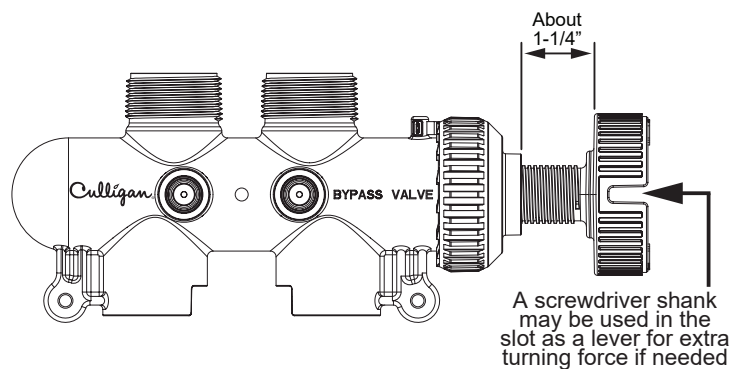

Softened Water

To return to SERVICE, turn the blue knob counter-clockwise (see directional arrow on end of knob) until the knob stops as shown in [Figure 2](#). DO NOT OVERTIGHTEN!

Things to Check Before You Call For Service

If you unexpectedly experience a change in the quality of your water, make these simple checks before calling your Culligan dealer. One of the following conditions may be the reason for the change.

Important

If any of the following conditions is found, the water softener should be manually regenerated according to instructions on "[Regeneration](#)" on [page 25](#) after you have corrected the problem.

Power Supply

Check your power supply cord. Is it plugged fully into the electric outlet? Be certain that the outlet is not controlled by a wall switch which has been turned off. Plug in the transformer then reset conditioner to the correct time of day.

Tripped Circuit Breaker

Check the house circuit breaker panel. Reset a tripped circuit breaker.

Power Failure

Any interruption in your power supply or time change—such as daylight savings—will disrupt your softener's regeneration schedule by causing the timer to run off-schedule. Reset the timer to the correct time of day.

Bypass Valves

Check to see if they are in the proper position. Cul-Flo-Valv[®] Bypass, if used, should be in the "Service" position (handle screwed out). If hand valves are used, see that inlet and outlet valve are opened and that the bypass valve is closed.

No Water

If you aren't getting any water flow at all, make sure your water supply is working. Open a tap ahead of the conditioner (outside tap) to see if you have any water pressure. If you have water pressure, check the bypass valve. If it is in the Service position, put it into the bypass and call your Culligan dealer for service.

Increased Usage

Guests, family additions, new water-using appliances, etc., will result in more water usage and may require additional programming by your local Culligan dealer. Please contact your local Culligan dealer.

Salt Level in Brine Tank

If there is no salt in the brine tank, add salt.

Performance Data Sheets

Culligan Aquasential Smart High Efficiency 9" and 9" Outdoor Water Softener

Culligan knows the more informed you are about your water treatment systems, the more confident you will be about its performance. It's because of this and more than seventy years of commitment to customer satisfaction that Culligan is providing this Performance Data Sheet to its customers.

NOTE! Read this Performance Data Sheet and compare the capabilities of this unit with your actual water treatment needs. It is recommended that before purchasing a water treatment unit, you have your water supply tested to determine your actual water treatment needs.

Manufacturer: Culligan International Company
9399 W. Higgins Rd., Suite 1100
Rosemont, IL 60018 USA
(847) 430-2800
www.culligan.com

Product: Culligan Aquasential Smart High Efficiency 9" and 9" Outdoor Water Softener

Testing Conditions & Results:

Flow Rate:	9.0 gpm @ 11 psi	Capacity:	19,003 grains @ 4.0 lb salt
Pressure:	30 - 40 psi		25,823 grains @ 8.0 lb salt
Acidity:	Non-Corrosive		29,622 grains @ 12.0 lb salt
Temperature:	68°F (20°C)	pH:	7.6
Efficiency Rated Dosage†:	4,751 gr/lb		

Softener Specifications:

Service Flow Rate:	9.0 gpm	Pressure Drop at Max. Flow Rate:	11 psi
Operating Temp. Range:	33 - 120°F (0 - 50°C)	Max. Drain Flow Rate:	2.38 gpm
Working Press. Range:	20 - 125 psi (140 - 860 kPa)	Oper. Press. Range (Canada):	20 - 90 psi (140 - 620 kPa)

Substance Reduction

While testing was performed under standard laboratory conditions, actual performance may vary.

Name of Substance	USEPA Max. Contaminant Level	pH	Flow Rate	Pressure
Barium	2.0 mg/L	7.5 + 0.5	9.0 gpm	11 (psig)
Radium 226/228	5 pCi/L	7.5 + 0.5	9.0 gpm	11 (psig)

This system is certified for barium and radium 226/228 reduction based on hardness reduction. It is recommended you test your water every 6 months to ensure the system is performing properly and that hardness, and therefore barium and radium 226/228, are being reduced.

The Culligan Aquasential Smart High Efficiency Series 9" and 9" Outdoor Water Softeners have been tested and certified by WQA against NSF/ANSI Standard 372, CSA B483.1, and NSF/ANSI Standard 44 for the effective reduction of hardness (calcium and magnesium), barium, and radium 226/228, as verified and substantiated by test data. To maintain product certification and ensure uniform performance, the product is retested on a consistent basis.



An efficiency rated water softener is a DIR softener which also complies with specific performance specifications intended to minimize the amount of regenerant brine and water used in its operation. Efficiency rated water softeners shall have a rated salt efficiency of not less than 3350 grains of total hardness exchange per pound of salt (based on NaCl equivalency) (477 grams of total hardness exchange per kilogram of salt), and shall not deliver more salt than its listed rating. The efficiency is measured by a laboratory test described in NSF/ANSI 44. The test represents the maximum possible efficiency the system can achieve. Operational efficiency is the actual efficiency achieved after the system has been installed. It is typically less than the efficiency due to individual application factors including water hardness, water usage, and other contaminants that reduce the softener's capacity.

Refer to the Specifications, Familiarization and Warranty section of this Owner's Guide (P/N 01040719) for more specific product information. To avoid contamination from improper handling and installation, your system should only be installed and serviced by your Culligan dealer. Performance will vary based on local water conditions. The substances reduced by this system are not necessarily in your water.

Culligan water softeners are designed to work with any salt of good quality, although it is recommended that you ask your local Culligan dealer for his suggestion on the best type and grade of salt to use in this softener.

NOTE! This softener is not intended to be used for treating water that is microbiologically unsafe or of unknown quality without adequate disinfection before or after the system.

†The efficiency rated dosage is only valid at the 4 lb salt dosage and maximum service flow rate for 9" models.

Culligan Aquasential Smart High Efficiency 10" and 10" Outdoor Water Softener

Culligan knows the more informed you are about your water treatment systems, the more confident you will be about its performance. It's because of this and more than seventy years of commitment to customer satisfaction that Culligan is providing this Performance Data Sheet to its customers.

NOTE! Read this Performance Data Sheet and compare the capabilities of this unit with your actual water treatment needs. It is recommended that before purchasing a water treatment unit, you have your water supply tested to determine your actual water treatment needs.

Manufacturer: Culligan International Company
9399 W. Higgins Rd., Suite 1100
Rosemont, IL 60018 USA
(847) 430-2800
www.culligan.com

Product: Culligan Aquasential Smart High Efficiency 10" and 10" Outdoor Water Softener

Testing Conditions & Results:

Flow Rate:	9.4 gpm @ 12 psi	Capacity:	30,439 grains @ 6.0 lb salt
Pressure:	30–40 psi		45,609 grains @ 12.0 lb salt
Acidity:	Non-Corrosive		48,623 grains @ 18.0 lb salt
Temperature:	68°F (20°C)	pH:	7.6
Efficiency Rated Dosage†:	5,073 gr/lb		

Softener Specifications:

Service Flow Rate:	9.4 gpm	Pressure Drop at Max. Flow Rate:	12 psi
Operating Temp. Range:	33–120°F (0–50°C)	Max. Drain Flow Rate:	2.0 gpm
Working Press. Range:	20–125 psi (140 - 860 kPa)	Oper. Press. Range (Canada):	20–90 psi (140 - 620 kPa)

Name of Substance	USEPA Max. Contaminant Level	pH	Flow Rate	Pressure
Barium	2.0 mg/L	7.5 + 0.5	9.4 gpm	12 (psig)
Radium 226/228	5 pCi/L	7.5 + 0.5	9.4 gpm	12 (psig)

This system is certified for barium and radium 226/228 reduction based on hardness reduction. It is recommended you test your water every 6 months to ensure the system is performing properly and that hardness, and therefore barium and radium 226/228, are being reduced.

The Culligan Aquasential Smart High Efficiency Series 10" and 10" Outdoor Water Softeners have been tested and certified by WQA against NSF/ANSI Standard 372, CSA B483.1, and NSF/ANSI Standard 44 for the effective reduction of hardness (calcium and magnesium), barium, and radium 226/228, as verified and substantiated by test data. To maintain product certification and ensure uniform performance, the product is retested on a consistent basis.

An efficiency rated water softener is a DIR softener which also complies with specific performance specifications intended to minimize the amount of regenerant brine and water used in its operation. Efficiency rated water softeners shall have a rated salt efficiency of not less than 3350 grains of total hardness exchange per pound of salt (based on NaCl equivalency) (477 grams of total hardness exchange per kilogram of salt), and shall not deliver more salt than its listed rating. The efficiency is measured by a laboratory test described in NSF/ANSI 44. The test represents the maximum possible efficiency the system can achieve. Operational efficiency is the actual efficiency achieved after the system has been installed. It is typically less than the efficiency due to individual application factors including water hardness, water usage, and other contaminants that reduce the softener's capacity.

Refer to the Specifications, Familiarization and Warranty section of this Owner's Guide (P/N 01040719) for more specific product information. To avoid contamination from improper handling and installation, your system should only be installed and serviced by your Culligan dealer. Performance will vary based on local water conditions. The substances reduced by this system are not necessarily in your water.

Culligan water softeners are designed to work with any salt of good quality, although it is recommended that you ask your local Culligan dealer for his suggestion on the best type and grade of salt to use in this softener.

NOTE! This softener is not intended to be used for treating water that is microbiologically unsafe or of unknown quality without adequate disinfection before or after the system.

† The efficiency rated dosage is only valid at the 6 lb salt dosage and maximum service flow rate for 10" models.



Culligan Aquasential Smart High Efficiency 12" and 12" Outdoor Water Softener

Culligan knows the more informed you are about your water treatment systems, the more confident you will be about its performance. It's because of this and more than seventy years of commitment to customer satisfaction that Culligan is providing this Performance Data Sheet to its customers.

NOTE! Read this Performance Data Sheet and compare the capabilities of this unit with your actual water treatment needs. It is recommended that before purchasing a water treatment unit, you have your water supply tested to determine your actual water treatment needs.

Manufacturer: Culligan International Company
9399 W. Higgins Rd., Suite 1100
Rosemont, IL 60018 USA
(847) 430-2800
www.culligan.com

Product: Culligan Aquasential Smart High Efficiency 12" and 12" Outdoor Water Softener

Testing Conditions & Results:

Flow Rate:	10.0 gpm @ 11 psi	Capacity:	28,365 grains @ 7.0 lb salt
Pressure:	30–40 psi		44,764 grains @ 16.0 lb salt
Acidity:	Non-Corrosive		58,658 grains @ 24.0 lb salt
Temperature:	68°F (20°C)	pH:	7.6
Efficiency Rated Dosage†:	4,052 gr/lb		

Softener Specifications:

Service Flow Rate:	10.0 gpm	Pressure Drop at Max. Flow Rate:	11 psi
Operating Temp. Range:	33–120°F (0–50°C)	Max. Drain Flow Rate:	2.79 gpm
Working Press. Range:	20–125 psi (140 - 860 kPa)	Oper. Press. Range (Canada):	20–90 psi (140 - 620 kPa)

Name of Substance	USEPA Max. Contaminant Level	pH	Flow Rate	Pressure
Barium	2.0 mg/L	7.5 + 0.5	10.0 gpm	11 (psig)
Radium 226/228	5 pCi/L	7.5 + 0.5	10.0 gpm	11 (psig)

This system is certified for barium and radium 226/228 reduction based on hardness reduction. It is recommended you test your water every 6 months to ensure the system is performing properly and that hardness, and therefore barium and radium 226/228, are being reduced.

The Culligan Aquasential Smart High Efficiency Series 12" and 12" Outdoor Water Softeners have been tested and certified by WQA against NSF/ANSI Standard 372, CSA B483.1, and NSF/ANSI Standard 44 for the effective reduction of hardness (calcium and magnesium), barium, and radium 226/228, as verified and substantiated by test data. To maintain product certification and ensure uniform performance, the product is retested on a consistent basis.

An efficiency rated water softener is a DIR softener which also complies with specific performance specifications intended to minimize the amount of regenerant brine and water used in its operation. Efficiency rated water softeners shall have a rated salt efficiency of not less than 3350 grains of total hardness exchange per pound of salt (based on NaCl equivalency) (477 grams of total hardness exchange per kilogram of salt), and shall not deliver more salt than its listed rating. The efficiency is measured by a laboratory test described in NSF/ANSI 44. The test represents the maximum possible efficiency the system can achieve. Operational efficiency is the actual efficiency achieved after the system has been installed. It is typically less than the efficiency due to individual application factors including water hardness, water usage, and other contaminants that reduce the softener's capacity.

Refer to the Specifications, Familiarization and Warranty section of this Owner's Guide (P/N 01040719) for more specific product information. To avoid contamination from improper handling and installation, your system should only be installed and serviced by your Culligan dealer. Performance will vary based on local water conditions. The substances reduced by this system are not necessarily in your water.

Culligan water softeners are designed to work with any salt of good quality, although it is recommended that you ask your local Culligan dealer for his suggestion on the best type and grade of salt to use in this softener.

NOTE! This softener is not intended to be used for treating water that is microbiologically unsafe or of unknown quality without adequate disinfection before or after the system.

† The efficiency rated dosage is only valid at the 7 lb salt dosage and maximum service flow rate for 12" models.



Culligan Aquasential Smart High Efficiency 14" and 14" Outdoor Water Softener

Culligan knows the more informed you are about your water treatment systems, the more confident you will be about its performance. It's because of this and more than seventy years of commitment to customer satisfaction that Culligan is providing this Performance Data Sheet to its customers.

NOTE! Read this Performance Data Sheet and compare the capabilities of this unit with your actual water treatment needs. It is recommended that before purchasing a water treatment unit, you have your water supply tested to determine your actual water treatment needs.

Manufacturer: Culligan International Company
9399 W. Higgins Rd., Suite 1100
Rosemont, IL 60018 USA
(847) 430-2800
www.culligan.com

Product: Culligan Aquasential Smart High Efficiency 14" and 14" Outdoor Water Softener

Testing Conditions & Results:

Flow Rate:	10.6 gpm @ 11 psi	Capacity:	42,548 grains @ 10.5 lb salt
Pressure:	30–40 psi		67,146 grains @ 24.0 lb salt
Acidity:	Non-Corrosive		87,987 grains @ 36.0 lb salt
Temperature:	68°F (20°C)	pH:	7.6
Efficiency Rated Dosage†:	4,052 gr/lb		

Softener Specifications:

Service Flow Rate:	10.6 gpm	Pressure Drop at Max. Flow Rate:	11 psi
Operating Temp. Range:	33–120°F (0–50°C)	Max. Drain Flow Rate:	5.28 gpm
Working Press. Range:	20–125 psi (140 - 860 kPa)	Oper. Press. Range (Canada):	20–90 psi (140 - 620 kPa)

Name of Substance	USEPA Max. Contaminant Level	pH	Flow Rate	Pressure
Barium	2.0 mg/L	7.5 + 0.5	10.6 gpm	11 (psig)
Radium 226/228	5 pCi/L	7.5 + 0.5	10.6 gpm	11 (psig)

This system is certified for barium and radium 226/228 reduction based on hardness reduction. It is recommended you test your water every 6 months to ensure the system is performing properly and that hardness, and therefore barium and radium 226/228, are being reduced.

The Culligan Aquasential Smart High Efficiency Series 14" and 14" Outdoor Water Softeners have been tested and certified by WQA against NSF/ANSI Standard 372, CSA B483.1, and NSF/ANSI Standard 44 for the effective reduction of hardness (calcium and magnesium), barium, and radium 226/228, as verified and substantiated by test data. To maintain product certification and ensure uniform performance, the product is retested on a consistent basis.

An efficiency rated water softener is a DIR softener which also complies with specific performance specifications intended to minimize the amount of regenerant brine and water used in its operation. Efficiency rated water softeners shall have a rated salt efficiency of not less than 3350 grains of total hardness exchange per pound of salt (based on NaCl equivalency) (477 grams of total hardness exchange per kilogram of salt), and shall not deliver more salt than its listed rating. The efficiency is measured by a laboratory test described in NSF/ANSI 44. The test represents the maximum possible efficiency the system can achieve. Operational efficiency is the actual efficiency achieved after the system has been installed. It is typically less than the efficiency due to individual application factors including water hardness, water usage, and other contaminants that reduce the softener's capacity.

Refer to the Specifications, Familiarization and Warranty section of this Owner's Guide (P/N 01040719) for more specific product information. To avoid contamination from improper handling and installation, your system should only be installed and serviced by your Culligan dealer. Performance will vary based on local water conditions. The substances reduced by this system are not necessarily in your water.

Culligan water softeners are designed to work with any salt of good quality, although it is recommended that you ask your local Culligan dealer for his suggestion on the best type and grade of salt to use in this softener.

NOTE! This softener is not intended to be used for treating water that is microbiologically unsafe or of unknown quality without adequate disinfection before or after the system.

† The efficiency rated dosage is only valid at the 10.5 lb salt dosage and maximum service flow rate for 14" models.



Culligan Aquasential Smart High Efficiency 9" Upflow and 9" Upflow Outdoor Water Softener

Culligan knows the more informed you are about your water treatment systems, the more confident you will be about its performance. It's because of this and more than seventy years of commitment to customer satisfaction that Culligan is providing this Performance Data Sheet to its customers.

NOTE! Read this Performance Data Sheet and compare the capabilities of this unit with your actual water treatment needs. It is recommended that before purchasing a water treatment unit, you have your water supply tested to determine your actual water treatment needs.

Manufacturer: Culligan International Company
 9399 W. Higgins Rd., Suite 1100
 Rosemont, IL 60018 USA
 (847) 430-2800
www.culligan.com

Product: Culligan Aquasential Smart High Efficiency 9" Upflow and 9" Upflow Outdoor Water Softener

Testing Conditions & Results:

Flow Rate:	9.0 gpm @ 11 psi	Capacity:	10,209 grains @ 2.0 lb salt
Pressure:	30–40 psi		16,666 grains @ 4.0 lb salt
Acidity:	Non-Corrosive		25,116 grains @ 8.0 lb salt
Temperature:	68°F (20°C)	pH:	7.6
Efficiency Rated Dosage†:	5,105 gr/lb		

Softener Specifications:

Service Flow Rate:	9.0 gpm	Pressure Drop at Max. Flow Rate:	11 psi
Operating Temp. Range:	33–120°F (0–50°C)	Max. Drain Flow Rate:	1.98 gpm
Working Press. Range:	20–125 psi (140 - 860 kPa)	Oper. Press. Range (Canada):	20–90 psi (140 - 620 kPa)

Name of Substance	USEPA Max. Contaminant Level	pH	Flow Rate	Pressure
Barium	2.0 mg/L	7.5 + 0.5	9.0 gpm	11 (psig)
Radium 226/228	5 pCi/L	7.5 + 0.5	9.0 gpm	11 (psig)

This system is certified for barium and radium 226/228 reduction based on hardness reduction. It is recommended you test your water every six months to ensure the system is performing properly and that hardness, and therefore barium and radium 226/228, are being reduced.

The Culligan Aquasential Smart High Efficiency Series 9" Upflow and 9" Upflow Outdoor Water Softeners have been tested and certified by WQA against NSF/ANSI Standard 372, CSA B483.1, and NSF/ANSI Standard 44 for the effective reduction of hardness (calcium and magnesium), barium, and radium 226/228, as verified and substantiated by test data. To maintain product certification and ensure uniform performance, the product is retested on a consistent basis.



An efficiency rated water softener is a DIR softener which also complies with specific performance specifications intended to minimize the amount of regenerant brine and water used in its operation. Efficiency rated water softeners shall have a rated salt efficiency of not less than 3350 grains of total hardness exchange per pound of salt (based on NaCl equivalency) (477 grams of total hardness exchange per kilogram of salt), and shall not deliver more salt than its listed rating. The efficiency is measured by a laboratory test described in NSF/ANSI 44. The test represents the maximum possible efficiency the system can achieve. Operational efficiency is the actual efficiency achieved after the system has been installed. It is typically less than the efficiency due to individual application factors including water hardness, water usage, and other contaminants that reduce the softener's capacity.

Refer to the Specifications, Familiarization and Warranty section of this Owner's Guide (P/N 01040719) for more specific product information. To avoid contamination from improper handling and installation, your system should only be installed and serviced by your Culligan dealer. Performance will vary based on local water conditions. The substances reduced by this system are not necessarily in your water.

Culligan water softeners are designed to work with any salt of good quality, although it is recommended that you ask your local Culligan dealer for his suggestion on the best type and grade of salt to use in this softener.

NOTE! This softener is not intended to be used for treating water that is microbiologically unsafe or of unknown quality without adequate disinfection before or after the system.

† The efficiency rated dosage is only valid at the 2 lb salt dosage and maximum service flow rate for 9" models.

Culligan Aquasential Smart High Efficiency 10" Upflow and 10" Upflow Outdoor Water Softener

Culligan knows the more informed you are about your water treatment systems, the more confident you will be about its performance. It's because of this and more than seventy years of commitment to customer satisfaction that Culligan is providing this Performance Data Sheet to its customers.

NOTE! Read this Performance Data Sheet and compare the capabilities of this unit with your actual water treatment needs. It is recommended that before purchasing a water treatment unit, you have your water supply tested to determine your actual water treatment needs.

Manufacturer: Culligan International Company
9399 W. Higgins Rd., Suite 1100
Rosemont, IL 60018 USA
(847) 430-2800
www.culligan.com

Product: Culligan Aquasential Smart High Efficiency 10" Upflow and 10" Upflow Outdoor Water Softener

Testing Conditions & Results:

Flow Rate:	9.4 gpm @ 12 psi	Capacity:	15,314 grains @ 3.0 lb salt
Pressure:	30–40 psi		24,999 grains @ 6.0 lb salt
Acidity:	Non-Corrosive		37,674 grains @ 12.0 lb salt
Temperature:	68°F (20°C)	pH:	7.6
Efficiency Rated Dosage†:	5,105 gr/lb		

Softener Specifications:

Service Flow Rate:	9.4 gpm	Pressure Drop at Max. Flow Rate:	12 psi
Operating Temp. Range:	33–120°F (0–50°C)	Max. Drain Flow Rate:	1.98 gpm
Working Press. Range:	20–125 psi (140 - 860 kPa)	Oper. Press. Range (Canada):	20–90 psi (140 - 620 kPa)

Name of Substance	USEPA Max. Contaminant Level	pH	Flow Rate	Pressure
Barium	2.0 mg/L	7.5 + 0.5	9.4 gpm	12 (psig)
Radium 226/228	5 pCi/L	7.5 + 0.5	9.4 gpm	12 (psig)

This system is certified for barium and radium 226/228 reduction based on hardness reduction. It is recommended you test your water every six months to ensure the system is performing properly and that hardness, and therefore barium and radium 226/228, are being reduced.

The Culligan Aquasential Smart High Efficiency 10" Upflow and 10" Upflow Outdoor Water Softeners have been tested and certified by WQA against NSF/ANSI Standard 372, CSA B483.1, and NSF/ANSI Standard 44 for the effective reduction of hardness (calcium and magnesium), barium, and radium 226/228, as verified and substantiated by test data. To maintain product certification and ensure uniform performance, the product is retested on a consistent basis.



An efficiency rated water softener is a DIR softener which also complies with specific performance specifications intended to minimize the amount of regenerant brine and water used in its operation. Efficiency rated water softeners shall have a rated salt efficiency of not less than 3350 grains of total hardness exchange per pound of salt (based on NaCl equivalency) (477 grams of total hardness exchange per kilogram of salt), and shall not deliver more salt than its listed rating. The efficiency is measured by a laboratory test described in NSF/ANSI 44. The test represents the maximum possible efficiency the system can achieve. Operational efficiency is the actual efficiency achieved after the system has been installed. It is typically less than the efficiency due to individual application factors including water hardness, water usage, and other contaminants that reduce the softener's capacity.

Refer to the Specifications, Familiarization and Warranty section of this Owner's Guide (P/N 01040719) for more specific product information. To avoid contamination from improper handling and installation, your system should only be installed and serviced by your Culligan dealer. Performance will vary based on local water conditions. The substances reduced by this system are not necessarily in your water.

Culligan water softeners are designed to work with any salt of good quality, although it is recommended that you ask your local Culligan dealer for his suggestion on the best type and grade of salt to use in this softener.

NOTE! This softener is not intended to be used for treating water that is microbiologically unsafe or of unknown quality without adequate disinfection before or after the system.

† The efficiency rated dosage is only valid at the 3 lb salt dosage and maximum service flow rate for 10" models.

Culligan Aquasential Smart High Efficiency Municipal 9" and Municipal 9" Outdoor Water Softener

Culligan knows the more informed you are about your water treatment systems, the more confident you will be about its performance. It's because of this and more than seventy years of commitment to customer satisfaction that Culligan is providing this Performance Data Sheet to its customers.

NOTE! Read this Performance Data Sheet and compare the capabilities of this unit with your actual water treatment needs. It is recommended that before purchasing a water treatment unit, you have your water supply tested to determine your actual water treatment needs.

Manufacturer: Culligan International Company
9399 W. Higgins Rd., Suite 1100
Rosemont, IL 60018 USA
(847) 430-2800
www.culligan.com

Product: Culligan Aquasential Smart High Efficiency Municipal 9" and Municipal 9" Outdoor Water Softener

Testing Conditions & Results:

Flow Rate:	9.0 gpm @ 11 psi	Capacity:	16,789 grains @ 4.0 lb salt
Pressure:	30–40 psi		22,827 grains @ 8.0 lb salt
Acidity:	Non-Corrosive		25,989 grains @ 12.0 lb salt
Temperature:	68°F (20°C)	pH:	7.6
Efficiency Rated Dosage†:	4,198 gr/lb		
Chlorine Taste and Odor Capacity:	300,000 gallons		

Softener Specifications:

Service Flow Rate:	9.0 gpm	Pressure Drop at Max. Flow Rate:	11 psi
Operating Temp. Range:	33–120°F (0–50°C)	Max. Drain Flow Rate:	2.58 gpm
Working Press. Range:	20–125 psi (140 - 860 kPa)	Oper. Press. Range (Canada):	20–90 psi (140 - 620 kPa)

Substance Reduction

This system has been tested according to NSF/ANSI 42 for reduction of the substance listed below. The concentration of the indicated substance in water entering the system was reduced to a concentration less than or equal to the permissible limit for water leaving the system, as specified in NSF/ANSI 42. While testing was performed under standard laboratory conditions, actual performance may vary.

Name of Substance	Influent Challenge Concentration	Reduction Requirement
Chlorine	2.0 mg/L ±10%	≥50%

Name of Substance	USEPA Max. Contaminant Level	pH	Flow Rate	Pressure
Barium	2.0 mg/L	7.5 + 0.5	9.0 gpm	11 (psig)
Radium 226/228	5 pCi/L	7.5 + 0.5	9.0 gpm	11 (psig)

This system is certified for barium and radium 226/228 reduction based on hardness reduction. It is recommended you test your water every six months to ensure the system is performing properly and that hardness, and therefore barium and radium 226/228, are being reduced.

The Culligan Aquasential Smart High Efficiency Municipal 9" and Municipal 9" Outdoor Water Softeners have been tested and certified by WQA against NSF/ANSI Standard 372, CSA B483.1, and NSF/ANSI Standard 44 for the effective reduction of hardness (calcium and magnesium), barium, and radium 226/228, and NSF/ANSI Standard 42 for the effective reduction of Chlorine Taste and Odor, as verified and substantiated by test data. To maintain product certification and ensure uniform performance, the product is retested on a consistent basis.



An efficiency rated water softener is a DIR softener which also complies with specific performance specifications intended to minimize the amount of regenerant brine and water used in its operation. Efficiency rated water softeners shall have a rated salt efficiency of not less than 3350 grains of total hardness exchange per pound of salt (based on NaCl equivalency) (477 grams of total hardness exchange per kilogram of salt), and shall not deliver more salt than its listed rating. The efficiency is measured by a laboratory test described in NSF/ANSI 44. The test represents the maximum possible efficiency the system can achieve. Operational efficiency is the actual efficiency achieved after the system has been installed. It is typically less than the efficiency due to individual application factors including water hardness, water usage, and other contaminants that reduce the softener's capacity.

Refer to the Specifications, Familiarization and Warranty section of this Owner's Guide (P/N 01040719) for more specific product information. To avoid contamination from improper handling and installation, your system should only be installed and serviced by your Culligan dealer. Performance will vary based on local water conditions. The substances reduced by this system are not necessarily in your water.

Culligan water softeners are designed to work with any salt of good quality, although it is recommended that you ask your local Culligan dealer for his suggestion on the best type and grade of salt to use in this softener.

NOTE! This softener is not intended to be used for treating water that is microbiologically unsafe or of unknown quality without adequate disinfection before or after the system.

† The efficiency rated dosage is valid only at the 4 lb salt dosage and 9.0 gpm flow rate for 9" models.

Culligan Aquasential Smart High Efficiency Municipal 10" and Municipal 10" Outdoor Water Softener

Culligan knows the more informed you are about your water treatment systems, the more confident you will be about its performance. It's because of this and more than seventy years of commitment to customer satisfaction that Culligan is providing this Performance Data Sheet to its customers.

NOTE! Read this Performance Data Sheet and compare the capabilities of this unit with your actual water treatment needs. It is recommended that before purchasing a water treatment unit, you have your water supply tested to determine your actual water treatment needs.

Manufacturer: Culligan International Company
9399 W. Higgins Rd., Suite 1100
Rosemont, IL 60018 USA
(847) 430-2800
www.culligan.com

Product: Culligan Aquasential Smart High Efficiency Municipal 10" and Municipal 10" Outdoor Water Softener

Testing Conditions & Results:

Flow Rate:	9.4 gpm @ 11 psi	Capacity:	20,986 grains @ 5.0 lb salt
Pressure:	30–40 psi		28,534 grains @ 10.0 lb salt
Acidity:	Non-Corrosive		32,486 grains @ 15.0 lb salt
Temperature:	68°F (20°C)	pH:	7.6
Efficiency Rated Dosage†:	4,197 gr/lb		
Chlorine Taste and Odor Capacity:	339,000 gallons		

Softener Specifications:

Service Flow Rate:	9.4 gpm	Pressure Drop at Max. Flow Rate:	11 psi
Operating Temp. Range:	33–120°F (0–50°C)	Max. Drain Flow Rate:	2.6 gpm
Working Press. Range:	20–125 psi (140 - 860 kPa)	Oper. Press. Range (Canada):	20–90 psi (140 - 620 kPa)

Substance Reduction

This system has been tested according to NSF/ANSI 42 for reduction of the substance listed below. The concentration of the indicated substance in water entering the system was reduced to a concentration less than or equal to the permissible limit for water leaving the system, as specified in NSF/ANSI 42. While testing was performed under standard laboratory conditions, actual performance may vary.

Name of Substance	Influent Challenge Concentration	Reduction Requirement
Chlorine	2.0 mg/L ±10%	≥50%

Name of Substance	USEPA Max. Contaminant Level	pH	Flow Rate	Pressure
Barium	2.0 mg/L	7.5 + 0.5	9.4 gpm	11 (psig)
Radium 226/228	5 pCi/L	7.5 + 0.5	9.4 gpm	11 (psig)

This system is certified for barium and radium 226/228 reduction based on hardness reduction. It is recommended you test your water every six months to ensure the system is performing properly and that hardness, and therefore barium and radium 226/228, are being reduced.

The Culligan Aquasential Smart High Efficiency Municipal 10" and Municipal 10" Outdoor Water Softeners have been tested and certified by WQA against NSF/ANSI Standard 372, CSA B483.1, and NSF/ANSI Standard 44 for the effective reduction of hardness (calcium and magnesium), barium, and radium 226/228, and NSF/ANSI Standard 42 for the effective reduction of Chlorine Taste and Odor, as verified and substantiated by test data. To maintain product certification and ensure uniform performance, the product is retested on a consistent basis.



An efficiency rated water softener is a DIR softener which also complies with specific performance specifications intended to minimize the amount of regenerant brine and water used in its operation. Efficiency rated water softeners shall have a rated salt efficiency of not less than 3350 grains of total hardness exchange per pound of salt (based on NaCl equivalency) (477 grams of total hardness exchange per kilogram of salt), and shall not deliver more salt than its listed rating. The efficiency is measured by a laboratory test described in NSF/ANSI 44. The test represents the maximum possible efficiency the system can achieve. Operational efficiency is the actual efficiency achieved after the system has been installed. It is typically less than the efficiency due to individual application factors including water hardness, water usage, and other contaminants that reduce the softener's capacity.

Refer to the Specifications, Familiarization and Warranty section of this Owner's Guide (P/N 01040719) for more specific product information. To avoid contamination from improper handling and installation, your system should only be installed and serviced by your Culligan dealer. Performance will vary based on local water conditions. The substances reduced by this system are not necessarily in your water.

Culligan water softeners are designed to work with any salt of good quality, although it is recommended that you ask your local Culligan dealer for his suggestion on the best type and grade of salt to use in this softener.

NOTE! This softener is not intended to be used for treating water that is microbiologically unsafe or of unknown quality without adequate disinfection before or after the system.

† The efficiency rated dosage is valid only at the 5 lb salt dosage and 9.4 gpm flow rate for 10" models.

Culligan Aquasential Smart High Efficiency Municipal 12" and Municipal 12" Outdoor Water Softener

Culligan knows the more informed you are about your water treatment systems, the more confident you will be about its performance. It's because of this and more than seventy years of commitment to customer satisfaction that Culligan is providing this Performance Data Sheet to its customers.

NOTE! Read this Performance Data Sheet and compare the capabilities of this unit with your actual water treatment needs. It is recommended that before purchasing a water treatment unit, you have your water supply tested to determine your actual water treatment needs.

Manufacturer: Culligan International Company
9399 W. Higgins Rd., Suite 1100
Rosemont, IL 60018 USA
(847) 430-2800
www.culligan.com

Product: Culligan Aquasential Smart High Efficiency Municipal 12" and Municipal 12" Outdoor Water Softener

Testing Conditions & Results:

Flow Rate:	10.0 gpm @ 11 psi	Capacity:	28,045 grains @ 7.0 lb salt
Pressure:	30–40 psi		42,953 grains @ 18.0 lb salt
Acidity:	Non-Corrosive		48,620 grains @ 30.0 lb salt
Temperature:	68°F (20°C)	pH:	7.6
Efficiency Rated Dosage†:	4,006 gr/lb		
Chlorine Taste and Odor Capacity:	621,000 gallons		

Softener Specifications:

Service Flow Rate:	10.0 gpm	Pressure Drop at Max. Flow Rate:	11 psi
Operating Temp. Range:	33–120°F (0–50°C)	Max. Drain Flow Rate:	3.21 gpm
Working Press. Range:	20–125 psi (140 - 860 kPa)	Oper. Press. Range (Canada):	20–90 psi (140 - 620 kPa)

Substance Reduction

This system has been tested according to NSF/ANSI 42 for reduction of the substance listed below. The concentration of the indicated substance in water entering the system was reduced to a concentration less than or equal to the permissible limit for water leaving the system, as specified in NSF/ANSI 42. While testing was performed under standard laboratory conditions, actual performance may vary.

Name of Substance	Influent Challenge Concentration	Reduction Requirement
Chlorine	2.0 mg/L ±10%	≥50%

Name of Substance	USEPA Max. Contaminant Level	pH	Flow Rate	Pressure
Barium	2.0 mg/L	7.5 + 0.5	11 gpm	10 (psig)
Radium 226/228	5 pCi/L	7.5 + 0.5	11 gpm	10 (psig)

This system is certified for barium and radium 226/228 reduction based on hardness reduction. It is recommended you test your water every six months to ensure the system is performing properly and that hardness, and therefore barium and radium 226/228, are being reduced.

The Culligan Aquasential Smart High Efficiency Municipal 12" and Municipal 12" Outdoor Water Softeners have been tested and certified by WQA against NSF/ANSI Standard 372, CSA B483.1, and NSF/ANSI Standard 44 for the effective reduction of hardness (calcium and magnesium), barium, and radium 226/228, and NSF/ANSI Standard 42 for the effective reduction of Chlorine Taste and Odor, as verified and substantiated by test data. To maintain product certification and ensure uniform performance, the product is retested on a consistent basis.



An efficiency rated water softener is a DIR softener which also complies with specific performance specifications intended to minimize the amount of regenerant brine and water used in its operation. Efficiency rated water softeners shall have a rated salt efficiency of not less than 3350 grains of total hardness exchange per pound of salt (based on NaCl equivalency) (477 grams of total hardness exchange per kilogram of salt), and shall not deliver more salt than its listed rating. The efficiency is measured by a laboratory test described in NSF/ANSI 44. The test represents the maximum possible efficiency the system can achieve. Operational efficiency is the actual efficiency achieved after the system has been installed. It is typically less than the efficiency due to individual application factors including water hardness, water usage, and other contaminants that reduce the softener's capacity.

Refer to the Specifications, Familiarization and Warranty section of this Owner's Guide (P/N 01040719) for more specific product information. To avoid contamination from improper handling and installation, your system should only be installed and serviced by your Culligan dealer. Performance will vary based on local water conditions. The substances reduced by this system are not necessarily in your water.

Culligan water softeners are designed to work with any salt of good quality, although it is recommended that you ask your local Culligan dealer for his suggestion on the best type and grade of salt to use in this softener.

NOTE! This softener is not intended to be used for treating water that is microbiologically unsafe or of unknown quality without adequate disinfection before or after the system.

† The efficiency rated dosage is valid only at the 7 lb salt dosage and 10.0 gpm flow rate for 12" models.

Culligan Aquasential Smart High Efficiency Municipal 14" and Municipal 14" Outdoor Water Softener

Culligan knows the more informed you are about your water treatment systems, the more confident you will be about its performance. It's because of this and more than seventy years of commitment to customer satisfaction that Culligan is providing this Performance Data Sheet to its customers.

NOTE! Read this Performance Data Sheet and compare the capabilities of this unit with your actual water treatment needs. It is recommended that before purchasing a water treatment unit, you have your water supply tested to determine your actual water treatment needs.

Manufacturer: Culligan International Company
 9399 W. Higgins Rd., Suite 1100
 Rosemont, IL 60018 USA
 (847) 430-2800
www.culligan.com

Product: Culligan Aquasential Smart High Efficiency Municipal 14" and Municipal 14" Outdoor Water Softener

Testing Conditions & Results:

Flow Rate:	10.6 gpm @ 11 psi	Capacity:	42,943 grains @ 10.7 lb salt
Pressure:	30–40 psi		54,597 grains @ 18.0 lb salt
Acidity:	Non-Corrosive		66,230 grains @ 28.0 lb salt
Temperature:	68°F (20°C)	pH:	7.6
Efficiency Rated Dosage†:	4,013 gr/lb		
Chlorine Taste and Odor Capacity:	931,500 gallons		

Softener Specifications:

Service Flow Rate:	10.6 gpm	Pressure Drop at Max. Flow Rate:	11 psi
Operating Temp. Range:	33–120°F (0–50°C)	Max. Drain Flow Rate:	6.2 gpm
Working Press. Range:	20–125 psi (140 - 860 kPa)	Oper. Press. Range (Canada):	20–90 psi (140 - 620 kPa)

Substance Reduction

This system has been tested according to NSF/ANSI 42 for reduction of the substance listed below. The concentration of the indicated substance in water entering the system was reduced to a concentration less than or equal to the permissible limit for water leaving the system, as specified in NSF/ANSI 42. While testing was performed under standard laboratory conditions, actual performance may vary.

Name of Substance	Influent Challenge Concentration	Reduction Requirement
Chlorine	2.0 mg/L ±10%	≥50%

Name of Substance	USEPA Max. Contaminant Level	pH	Flow Rate	Pressure
Barium	2.0 mg/L	7.5 + 0.5	10.6 gpm	11 (psig)
Radium 226/228	5 pCi/L	7.5 + 0.5	10.6 gpm	11 (psig)

This system is certified for barium and radium 226/228 reduction based on hardness reduction. It is recommended you test your water every six months to ensure the system is performing properly and that hardness, and therefore barium and radium 226/228, are being reduced.

The Culligan Aquasential Smart High Efficiency Municipal 14" and Municipal 14" Outdoor Water Softeners have been tested and certified by WQA against NSF/ANSI Standard 372, CSA B483.1, and NSF/ANSI Standard 44 for the effective reduction of hardness (calcium and magnesium), barium, and radium 226/228, and NSF/ANSI Standard 42 for the effective reduction of Chlorine Taste and Odor, as verified and substantiated by test data. To maintain product certification and ensure uniform performance, the product is retested on a consistent basis.



An efficiency rated water softener is a DIR softener which also complies with specific performance specifications intended to minimize the amount of regenerant brine and water used in its operation. Efficiency rated water softeners shall have a rated salt efficiency of not less than 3350 grains of total hardness exchange per pound of salt (based on NaCl equivalency) (477 grams of total hardness exchange per kilogram of salt), and shall not deliver more salt than its listed rating. The efficiency is measured by a laboratory test described in NSF/ANSI 44. The test represents the maximum possible efficiency the system can achieve. Operational efficiency is the actual efficiency achieved after the system has been installed. It is typically less than the efficiency due to individual application factors including water hardness, water usage, and other contaminants that reduce the softener's capacity.

Refer to the Specifications, Familiarization and Warranty section of this Owner's Guide (P/N 01040719) for more specific product information. To avoid contamination from improper handling and installation, your system should only be installed and serviced by your Culligan dealer. Performance will vary based on local water conditions. The substances reduced by this system are not necessarily in your water.

Culligan water softeners are designed to work with any salt of good quality, although it is recommended that you ask your local Culligan dealer for his suggestion on the best type and grade of salt to use in this softener.

NOTE! This softener is not intended to be used for treating water that is microbiologically unsafe or of unknown quality without adequate disinfection before or after the system.

† The efficiency rated dosage is valid only at the 10.7 lb salt dosage and 10.6 gpm flow rate for 14" models.

Culligan Aquasential Smart High Efficiency 9" Softener-Clear Water Conditioner

Culligan knows the more informed you are about your water treatment systems, the more confident you will be about its performance. It's because of this and more than seventy years of commitment to customer satisfaction that Culligan is providing this Performance Data Sheet to its customers.

NOTE! Read this Performance Data Sheet and compare the capabilities of this unit with your actual water treatment needs. It is recommended that before purchasing a water treatment unit, you have your water supply tested to determine your actual water treatment needs.

Manufacturer: Culligan International Company
9399 W. Higgins Rd., Suite 1100
Rosemont, IL 60018 USA
(847) 430-2800
www.culligan.com

Product: Culligan Aquasential Smart High Efficiency 9" Softener-Clear Water Conditioner

Testing Conditions & Results:

Flow Rate:	9.0 gpm @ 12 psi	Capacity:	19,003 grains @ 4.0 lb salt
Pressure:	30-40 psi		25,823 grains @ 8.0 lb salt
Acidity:	Non-Corrosive		29,622 grains @ 12.0 lb salt
Temperature:	68°F (20°C)	pH:	7.6
Efficiency Rated Dosage†:	4,751 gr/lb		

Softener Specifications:

Service Flow Rate:	9.0 gpm	Max. Drain Flow Rate:	2.34 gpm
Operating Temp. Range:	33-120°F (0-50°C)	Pressure Drop at Max. Flow Rate:	12 psi
Working Press. Range:	20-125 psi (140 - 860 kPa)	Oper. Press. Range (Canada):	20-90 psi (140 - 620 kPa)

Name of Substance	USEPA Max. Contaminant Level	pH	Flow Rate	Pressure
Barium	2.0 mg/L	7.5 + 0.5	9.0 gpm	12 (psig)
Radium 226/228	5 pCi/L	7.5 + 0.5	9.0 gpm	12 (psig)

This system is certified for barium and radium 226/228 reduction based on hardness reduction. It is recommended you test your water every six months to ensure the system is performing properly and that hardness, and therefore barium and radium 226/228, are being reduced. Hardness test strips have been included. Additional strips are available from your local Culligan dealer.

The Culligan Aquasential Smart High Efficiency 9" Softener-Clear Water Conditioners have been tested and certified by WQA against CSA B483.1, NSF/ANSI Standard 372 for the low lead compliance, NSF/ANSI Standard 44 for the effective reduction of hardness (calcium and magnesium), barium, and radium 226/228, and NSF/ANSI 42 for the effective iron reduction up to 11 ppm, as verified and substantiated by test data.



An efficiency rated water softener is a DIR softener which also complies with specific performance specifications intended to minimize the amount of regenerant brine and water used in its operation. Efficiency rated water softeners shall have a rated salt efficiency of not less than 3350 grains of total hardness exchange per pound of salt (based on NaCl equivalency) (477 grams of total hardness exchange per kilogram of salt), and shall not deliver more salt than its listed rating. The efficiency is measured by a laboratory test described in NSF/ANSI 44. The test represents the maximum possible efficiency the system can achieve. Operational efficiency is the actual efficiency achieved after the system has been installed. It is typically less than the efficiency due to individual application factors including water hardness, water usage, and other contaminants that reduce the softener's capacity.

Dissolved Iron Reduction Testing Conditions and Results:

The Culligan Aquasential Smart High Efficiency 9" Softener-Clear Water Conditioner has been tested according to NSF/ANSI standard 42 for effective reduction of iron up to 2,000 gallons with influent dissolved iron level up to 11 ppm. The concentration of the indicated substances in water entering the system was reduced to a concentration less than or equal to the permissible limit for water leaving the system, as specified in NSF/ANSI 42.

Substance	Influent Challenge Concentration	Max Permissible Product Water Concentration	Flow Rate
Iron	9-11 mg/L	0.3 mg/L	9.0 gpm

Refer to the Specifications, Familiarization and Warranty section of this Owner's Guide (P/N 01040719) for more specific product information. To avoid contamination from improper handling and installation, your system should only be installed and serviced by your Culligan Man. Performance will vary based on local water conditions. The substances reduced by this system are not necessarily in your water.

Culligan water softeners are designed to work with any salt of good quality, although it is recommended that you ask your local Culligan dealer to suggest the best type and grade of salt to use in this softener.

NOTE! This softener is not intended to be used for treating water that is microbiologically unsafe or of unknown quality without adequate disinfection before or after the system.

† The efficiency rated dosage is only valid at the 4 lb salt dosage and maximum service flow rate for 9" models.

Culligan Aquasential Smart High Efficiency 10" Softener-Clear Water Conditioner

Culligan knows the more informed you are about your water treatment systems, the more confident you will be about its performance. It's because of this and more than seventy years of commitment to customer satisfaction that Culligan is providing this Performance Data Sheet to its customers.

NOTE! Read this Performance Data Sheet and compare the capabilities of this unit with your actual water treatment needs. It is recommended that before purchasing a water treatment unit, you have your water supply tested to determine your actual water treatment needs.

Manufacturer: Culligan International Company
9399 W. Higgins Rd., Suite 1100
Rosemont, IL 60018 USA
(847) 430-2800
www.culligan.com

Product: Culligan Aquasential Smart High Efficiency 10" Softener-Clear Water Conditioner

Testing Conditions & Results:

Flow Rate:	9.4 gpm @ 13 psi	Capacity:	28,391 grains @ 6.0 lb salt
Pressure:	30-40 psi		43,262 grains @ 12.0 lb salt
Acidity:	Non-Corrosive		48,129 grains @ 18.0 lb salt
Temperature:	68°F (20°C)	pH:	7.6
Efficiency Rated Dosage†:	4,732 gr/lb		

Softener Specifications:

Service Flow Rate:	9.4 gpm	Max. Drain Flow Rate:	2.5 gpm
Operating Temp. Range:	33-120°F (0-50°C)	Pressure Drop at Max. Flow Rate:	13 psi
Working Press. Range:	20-125 psi (140 - 860 kPa)	Oper. Press. Range (Canada):	20-90 psi (140 - 620 kPa)

Name of Substance	USEPA Max. Contaminant Level	pH	Flow Rate	Pressure
Barium	2.0 mg/L	7.5 + 0.5	9.4 gpm	13 (psig)
Radium 226/228	5 pCi/L	7.5 + 0.5	9.4 gpm	13 (psig)

This system is certified for barium and radium 226/228 reduction based on hardness reduction. It is recommended you test your water every six months to ensure the system is performing properly and that hardness, and therefore barium and radium 226/228, are being reduced. Hardness test strips have been included. Additional strips are available from your local Culligan dealer.

The Culligan Aquasential Smart High Efficiency 10" Softener-Clear Water Conditioners have been tested and certified by WQA against CSA B483.1, NSF/ANSI Standard 372 for the low lead compliance, NSF/ANSI Standard 44 for the effective reduction of hardness (calcium and magnesium), barium, and radium 226/228, and NSF/ANSI 42 for the effective iron reduction up to 11 ppm, as verified and substantiated by test data.



An efficiency rated water softener is a DIR softener which also complies with specific performance specifications intended to minimize the amount of regenerant brine and water used in its operation. Efficiency rated water softeners shall have a rated salt efficiency of not less than 3350 grains of total hardness exchange per pound of salt (based on NaCl equivalency) (477 grams of total hardness exchange per kilogram of salt), and shall not deliver more salt than its listed rating. The efficiency is measured by a laboratory test described in NSF/ANSI 44. The test represents the maximum possible efficiency the system can achieve. Operational efficiency is the actual efficiency achieved after the system has been installed. It is typically less than the efficiency due to individual application factors including water hardness, water usage, and other contaminants that reduce the softener's capacity.

Dissolved Iron Reduction Testing Conditions and Results:

The Culligan Aquasential Smart High Efficiency 10" Softener-Clear Water Conditioner has been tested according to NSF/ANSI standard 42 for effective reduction of iron up to 3,000 gallons with influent dissolved iron level up to 11 ppm. The concentration of the indicated substances in water entering the system was reduced to a concentration less than or equal to the permissible limit for water leaving the system, as specified in NSF/ANSI 42.

Substance	Influent Challenge Concentration	Max Permissible Product Water Concentration	Flow Rate
Iron	9-11 mg/L	0.3 mg/L	9.4 gpm

Refer to the Specifications, Familiarization and Warranty section of this Owner's Guide (P/N 01040719) for more specific product information. To avoid contamination from improper handling and installation, your system should only be installed and serviced by your Culligan Man. Performance will vary based on local water conditions. The substances reduced by this system are not necessarily in your water.

Culligan water softeners are designed to work with any salt of good quality, although it is recommended that you ask your local Culligan dealer to suggest the best type and grade of salt to use in this softener.

NOTE! This softener is not intended to be used for treating water that is microbiologically unsafe or of unknown quality without adequate disinfection before or after the system.

† The efficiency rated dosage is only valid at the 6 lb salt dosage and maximum service flow rate for 10" models.

Culligan Aquasential Smart High Efficiency 12" Softener-Clear Water Conditioner

Culligan knows the more informed you are about your water treatment systems, the more confident you will be about its performance. It's because of this and more than seventy years of commitment to customer satisfaction that Culligan is providing this Performance Data Sheet to its customers.

NOTE! Read this Performance Data Sheet and compare the capabilities of this unit with your actual water treatment needs. It is recommended that before purchasing a water treatment unit, you have your water supply tested to determine your actual water treatment needs.

Manufacturer: Culligan International Company
9399 W. Higgins Rd., Suite 1100
Rosemont, IL 60018 USA
(847) 430-2800
www.culligan.com

Product: Culligan Aquasential Smart High Efficiency 12" Softener-Clear Water Conditioner

Testing Conditions & Results:

Flow Rate:	10.0 gpm @ 11 psi	Capacity:	28,365 grains @ 7.0 lb salt
Pressure:	30-40 psi		44,764 grains @ 16.0 lb salt
Acidity:	Non-Corrosive		58,658 grains @ 24.0 lb salt
Temperature:	68°F (20°C)	pH:	7.6
Efficiency Rated Dosage†:	4,052 gr/lb		

Softener Specifications:

Service Flow Rate:	10.0 gpm	Max. Drain Flow Rate:	3.5 gpm
Operating Temp. Range:	33-120°F (0-50°C)	Pressure Drop at Max. Flow Rate:	11 psi
Working Press. Range:	20-125 psi (140 - 860 kPa)	Oper. Press. Range (Canada):	20-90 psi (140 - 620 kPa)

Name of Substance	USEPA Max. Contaminant Level	pH	Flow Rate	Pressure
Barium	2.0 mg/L	7.5 + 0.5	10.0 gpm	11 (psig)
Radium 226/228	5 pCi/L	7.5 + 0.5	10.0 gpm	11 (psig)

This system is certified for barium and radium 226/228 reduction based on hardness reduction. It is recommended you test your water every six months to ensure the system is performing properly and that hardness, and therefore barium and radium 226/228, are being reduced. Hardness test strips have been included. Additional strips are available from your local Culligan dealer.

The Culligan Aquasential Smart High Efficiency 12" Softener-Clear Water Conditioners have been tested and certified by WQA against CSA B483.1, NSF/ANSI Standard 372 for the low lead compliance, NSF/ANSI Standard 44 for the effective reduction of hardness (calcium and magnesium), barium, and radium 226/228, and NSF/ANSI 42 for the effective iron reduction up to 11 ppm, as verified and substantiated by test data.



An efficiency rated water softener is a DIR softener which also complies with specific performance specifications intended to minimize the amount of regenerant brine and water used in its operation. Efficiency rated water softeners shall have a rated salt efficiency of not less than 3350 grains of total hardness exchange per pound of salt (based on NaCl equivalency) (477 grams of total hardness exchange per kilogram of salt), and shall not deliver more salt than its listed rating. The efficiency is measured by a laboratory test described in NSF/ANSI 44. The test represents the maximum possible efficiency the system can achieve. Operational efficiency is the actual efficiency achieved after the system has been installed. It is typically less than the efficiency due to individual application factors including water hardness, water usage, and other contaminants that reduce the softener's capacity.

Dissolved Iron Reduction Testing Conditions and Results:

The Culligan Aquasential Smart High Efficiency 12" Softener-Clear Water Conditioner has been tested according to NSF/ANSI standard 42 for effective reduction of iron up to 4,000 gallons with influent dissolved iron level up to 11 ppm. The concentration of the indicated substances in water entering the system was reduced to a concentration less than or equal to the permissible limit for water leaving the system, as specified in NSF/ANSI 42.

Substance	Influent Challenge Concentration	Max Permissible Product Water Concentration	Flow Rate
Iron	9-11 mg/L	0.3 mg/L	10.0 gpm

Refer to the Specifications, Familiarization and Warranty section of this Owner's Guide (P/N 01040719) for more specific product information. To avoid contamination from improper handling and installation, your system should only be installed and serviced by your Culligan Man. Performance will vary based on local water conditions. The substances reduced by this system are not necessarily in your water.

Culligan water softeners are designed to work with any salt of good quality, although it is recommended that you ask your local Culligan dealer to suggest the best type and grade of salt to use in this softener.

NOTE! This softener is not intended to be used for treating water that is microbiologically unsafe or of unknown quality without adequate disinfection before or after the system.

† The efficiency rated dosage is only valid at the 7 lb salt dosage and maximum service flow rate for 12" models.

Culligan Aquasential Smart High Efficiency 14" Softener-Clear Water Conditioner

Culligan knows the more informed you are about your water treatment systems, the more confident you will be about its performance. It's because of this and more than seventy years of commitment to customer satisfaction that Culligan is providing this Performance Data Sheet to its customers.

NOTE! Read this Performance Data Sheet and compare the capabilities of this unit with your actual water treatment needs. It is recommended that before purchasing a water treatment unit, you have your water supply tested to determine your actual water treatment needs.

Manufacturer: Culligan International Company
9399 W. Higgins Rd., Suite 1100
Rosemont, IL 60018 USA
(847) 430-2800
www.culligan.com

Product: Culligan Aquasential Smart High Efficiency 14" Softener-Clear Water Conditioner

Testing Conditions & Results:

Flow Rate:	10.6 gpm @ 11 psi	Capacity:	42,548 grains @ 10.5 lb salt
Pressure:	30-40 psi		67,146 grains @ 24.0 lb salt
Acidity:	Non-Corrosive		87,987 grains @ 36.0 lb salt
Temperature:	68°F (20°C)	pH:	7.6
Efficiency Rated Dosage†:	4,052 gr/lb		

Softener Specifications:

Service Flow Rate:	10.6 gpm	Max. Drain Flow Rate:	5.28 gpm
Operating Temp. Range:	33-120°F (0-50°C)	Pressure Drop at Max. Flow Rate:	11 psi
Working Press. Range:	20-125 psi (140 - 860 kPa)	Oper. Press. Range (Canada):	20-90 psi (140 - 620 kPa)

Name of Substance	USEPA Max. Contaminant Level	pH	Flow Rate	Pressure
Barium	2.0 mg/L	7.5 + 0.5	10.6 gpm	11 (psig)
Radium 226/228	5 pCi/L	7.5 + 0.5	10.6 gpm	11 (psig)

This system is certified for barium and radium 226/228 reduction based on hardness reduction. It is recommended you test your water every six months to ensure the system is performing properly and that hardness, and therefore barium and radium 226/228, are being reduced. Hardness test strips have been included. Additional strips are available from your local Culligan dealer.

The Culligan Aquasential Smart High Efficiency 14" Softener-Clear Water Conditioners have been tested and certified by WQA against CSA B483.1, NSF/ANSI Standard 372 for the low lead compliance, NSF/ANSI Standard 44 for the effective reduction of hardness (calcium and magnesium), barium, and radium 226/228, and NSF/ANSI 42 for the effective iron reduction up to 11 ppm, as verified and substantiated by test data.



An efficiency rated water softener is a DIR softener which also complies with specific performance specifications intended to minimize the amount of regenerant brine and water used in its operation. Efficiency rated water softeners shall have a rated salt efficiency of not less than 3350 grains of total hardness exchange per pound of salt (based on NaCl equivalency) (477 grams of total hardness exchange per kilogram of salt), and shall not deliver more salt than its listed rating. The efficiency is measured by a laboratory test described in NSF/ANSI 44. The test represents the maximum possible efficiency the system can achieve. Operational efficiency is the actual efficiency achieved after the system has been installed. It is typically less than the efficiency due to individual application factors including water hardness, water usage, and other contaminants that reduce the softener's capacity.

Dissolved Iron Reduction Testing Conditions and Results:

The Culligan Aquasential Smart High Efficiency 14" Softener-Clear Water Conditioner has been tested according to NSF/ANSI standard 42 for effective reduction of iron up to 6,000 gallons with influent dissolved iron level up to 11 ppm. The concentration of the indicated substances in water entering the system was reduced to a concentration less than or equal to the permissible limit for water leaving the system, as specified in NSF/ANSI 42.

Substance	Influent Challenge Concentration	Max Permissible Product Water Concentration	Flow Rate
Iron	9-11 mg/L	0.3 mg/L	10.6 gpm

Refer to the Specifications, Familiarization and Warranty section of this Owner's Guide (P/N 01040719) for more specific product information. To avoid contamination from improper handling and installation, your system should only be installed and serviced by your Culligan Man. Performance will vary based on local water conditions. The substances reduced by this system are not necessarily in your water.

Culligan water softeners are designed to work with any salt of good quality, although it is recommended that you ask your local Culligan dealer to suggest the best type and grade of salt to use in this softener.

NOTE! This softener is not intended to be used for treating water that is microbiologically unsafe or of unknown quality without adequate disinfection before or after the system.

† The efficiency rated dosage is only valid at the 10.5 lb salt dosage and maximum service flow rate for 14" models.

Culligan Aquasential Smart High Efficiency 9" Softener-Clear Plus and 9" Softener-Clear Plus Outdoor Water Conditioner

Culligan knows the more informed you are about your water treatment systems, the more confident you will be about its performance. It's because of this and more than seventy years of commitment to customer satisfaction that Culligan is providing this Performance Data Sheet to its customers.

NOTE! Read this Performance Data Sheet and compare the capabilities of this unit with your actual water treatment needs. It is recommended that before purchasing a water treatment unit, you have your water supply tested to determine your actual water treatment needs.

Manufacturer: Culligan International Company
9399 W. Higgins Rd., Suite 1100
Rosemont, IL 60018 USA
(847) 430-2800
www.culligan.com

Product: Culligan Aquasential Smart High Efficiency 9" Softener-Clear Plus and 9" Softener-Clear Plus Outdoor Water Conditioner

Testing Conditions & Results:

Flow Rate:	8.0 gpm @ 9 psi	Capacity:	18,927 grains @ 4.0 lb salt
Pressure:	30-40 psi		28,841 grains @ 8.0 lb salt
Acidity:	Non-Corrosive		32,086 grains @ 12.0 lb salt
Temperature:	68°F (20°C)	pH:	7.6
Efficiency Rated Dosage†:	4,732 gr/lb		

Softener Specifications:

Service Flow Rate:	8.0 gpm	Max. Drain Flow Rate:	2.34 gpm
Operating Temp. Range:	33-120°F (0-50°C)	Pressure Drop at Max. Flow Rate:	9 psi
Working Press. Range:	20-125 psi (140 - 860 kPa)	Oper. Press. Range (Canada):	20-90 psi (140 - 620 kPa)

Name of Substance	USEPA Max. Contaminant Level	pH	Flow Rate	Pressure
Barium	2.0 mg/L	7.5 + 0.5	8.0 gpm	9 (psig)
Radium 226/228	5 pCi/L	7.5 + 0.5	8.0 gpm	9 (psig)

This system is certified for barium and radium 226/228 reduction based on hardness reduction. It is recommended you test your water every six months to ensure the system is performing properly and that hardness, and therefore barium and radium 226/228, are being reduced. Hardness test strips have been included. Additional strips are available from your local Culligan dealer.

The Culligan Aquasential Smart High Efficiency 9" Softener-Clear Plus and 9" Softener-Clear Plus Outdoor Water Conditioners have been tested and certified by WQA against CSA B483.1, NSF/ANSI Standard 372 for the low lead compliance, NSF/ANSI Standard 44 for the effective reduction of hardness (calcium and magnesium), barium, and radium 226/228, and NSF/ANSI 42 for the effective iron reduction up to 11 ppm, as verified and substantiated by test data.



An efficiency rated water softener is a DIR softener which also complies with specific performance specifications intended to minimize the amount of regenerant brine and water used in its operation. Efficiency rated water softeners shall have a rated salt efficiency of not less than 3350 grains of total hardness exchange per pound of salt (based on NaCl equivalency) (477 grams of total hardness exchange per kilogram of salt), and shall not deliver more salt than its listed rating. The efficiency is measured by a laboratory test described in NSF/ANSI 44. The test represents the maximum possible efficiency the system can achieve. Operational efficiency is the actual efficiency achieved after the system has been installed. It is typically less than the efficiency due to individual application factors including water hardness, water usage, and other contaminants that reduce the softener's capacity.

Dissolved Iron Reduction Testing Conditions and Results:

The Culligan Aquasential Smart High Efficiency 9" Softener-Clear Plus and 9" Softener-Clear Plus Outdoor Water Conditioners have been tested according to NSF/ANSI standard 42 for effective reduction of iron up to 2,000 gallons with influent dissolved iron level up to 11 ppm. The claim is only valid for flow rate restricted to 4 gpm. The concentration of the indicated substances in water entering the system was reduced to a concentration less than or equal to the permissible limit for water leaving the system, as specified in NSF/ANSI 42.

Substance	Influent Challenge Concentration	Max Permissible Product Water Concentration	Flow Rate
Iron	9-11 mg/L	0.3 mg/L	4.0 gpm

Refer to the Specifications, Familiarization and Warranty section of this Owner's Guide (P/N 01040719) for more specific product information. To avoid contamination from improper handling and installation, your system should only be installed and serviced by your Culligan Man. Performance will vary based on local water conditions. The substances reduced by this system are not necessarily in your water.

Culligan water softeners are designed to work with any salt of good quality, although it is recommended that you ask your local Culligan dealer to suggest the best type and grade of salt to use in this softener.

NOTE! This softener is not intended to be used for treating water that is microbiologically unsafe or of unknown quality without adequate disinfection before or after the system.

† The efficiency rated dosage is only valid at the 4 lb salt dosage and maximum service flow rate for 9" models.

Culligan Aquasential Smart High Efficiency 10" Softener-Clear Plus Water Conditioner

Culligan knows the more informed you are about your water treatment systems, the more confident you will be about its performance. It's because of this and more than seventy years of commitment to customer satisfaction that Culligan is providing this Performance Data Sheet to its customers.

NOTE! Read this Performance Data Sheet and compare the capabilities of this unit with your actual water treatment needs. It is recommended that before purchasing a water treatment unit, you have your water supply tested to determine your actual water treatment needs.

Manufacturer: Culligan International Company
9399 W. Higgins Rd., Suite 1100
Rosemont, IL 60018 USA
(847) 430-2800
www.culligan.com

Product: Culligan Aquasential Smart High Efficiency 10" Softener-Clear Plus Water Conditioner

Testing Conditions & Results:

Flow Rate:	9.9 gpm @ 14 psi	Capacity:	28,391 grains @ 6.0 lb salt
Pressure:	30-40 psi		43,262 grains @ 12.0 lb salt
Acidity:	Non-Corrosive		48,129 grains @ 18.0 lb salt
Temperature:	68°F (20°C)	pH:	7.6
Efficiency Rated Dosage†:	4,732 gr/lb		

Softener Specifications:

Service Flow Rate:	9.9 gpm	Max. Drain Flow Rate:	2.5 gpm
Operating Temp. Range:	33-120°F (0-50°C)	Pressure Drop at Max. Flow Rate:	14 psi
Working Press. Range:	20-125 psi (140 - 860 kPa)	Oper. Press. Range (Canada):	20-90 psi (140 - 620 kPa)

Name of Substance	USEPA Max. Contaminant Level	pH	Flow Rate	Pressure
Barium	2.0 mg/L	7.5 + 0.5	9.9 gpm	14 (psig)
Radium 226/228	5 pCi/L	7.5 + 0.5	9.9 gpm	14 (psig)

This system is certified for barium and radium 226/228 reduction based on hardness reduction. It is recommended you test your water every six months to ensure the system is performing properly and that hardness, and therefore barium and radium 226/228, are being reduced. Hardness test strips have been included. Additional strips are available from your local Culligan dealer.

The Culligan Aquasential Smart High Efficiency 10" Softener-Clear Plus Water Conditioners have been tested and certified by WQA against CSA B483.1, NSF/ANSI Standard 372 for the low lead compliance, NSF/ANSI Standard 44 for the effective reduction of hardness (calcium and magnesium), barium, and radium 226/228, and NSF/ANSI 42 for the effective iron reduction up to 11 ppm, as verified and substantiated by test data.



An efficiency rated water softener is a DIR softener which also complies with specific performance specifications intended to minimize the amount of regenerant brine and water used in its operation. Efficiency rated water softeners shall have A rated salt efficiency of not less than 3350 grains of total hardness exchange per pound of salt (based on NaCl equivalency) (477 grams of total hardness exchange per kilogram of salt), and shall not deliver more salt than its listed rating. The efficiency is measured by a laboratory test described in NSF/ANSI 44. The test represents the maximum possible efficiency the system can achieve. Operational efficiency is the actual efficiency achieved after the system has been installed. It is typically less than the efficiency due to individual application factors including water hardness, water usage, and other contaminants that reduce the softener's capacity.

Dissolved Iron Reduction Testing Conditions and Results:

The Culligan Aquasential Smart High Efficiency 10" Softener-Clear Plus Water Conditioner has been tested according to NSF/ANSI standard 42 for effective reduction of iron up to 3,000 gallons with influent dissolved iron level up to 11 ppm. The claim is only valid for flow rate restricted to 5.9 gpm. The concentration of the indicated substances in water entering the system was reduced to a concentration less than or equal to the permissible limit for water leaving the system, as specified in NSF/ANSI 42.

Substance	Influent Challenge Concentration	Max Permissible Product Water Concentration	Flow Rate
Iron	9-11 mg/L	0.3 mg/L	5.9 gpm

Refer to the Specifications, Familiarization and Warranty section of this Owner's Guide (P/N 01040719) for more specific product information. To avoid contamination from improper handling and installation, your system should only be installed and serviced by your Culligan Man. Performance will vary based on local water conditions. The substances reduced by this system are not necessarily in your water.

Culligan water softeners are designed to work with any salt of good quality, although it is recommended that you ask your local Culligan dealer to suggest the best type and grade of salt to use in this softener.

NOTE! This softener is not intended to be used for treating water that is microbiologically unsafe or of unknown quality without adequate disinfection before or after the system.

† The efficiency rated dosage is only valid at the 6 lb salt dosage and maximum service flow rate for 10" models.

Culligan Aquasential Smart High Efficiency 12" Softener-Clear Plus Water Conditioner

Culligan knows the more informed you are about your water treatment systems, the more confident you will be about its performance. It's because of this and more than seventy years of commitment to customer satisfaction that Culligan is providing this Performance Data Sheet to its customers.

NOTE! Read this Performance Data Sheet and compare the capabilities of this unit with your actual water treatment needs. It is recommended that before purchasing a water treatment unit, you have your water supply tested to determine your actual water treatment needs.

Manufacturer: Culligan International Company
9399 W. Higgins Rd., Suite 1100
Rosemont, IL 60018 USA
(847) 430-2800
www.culligan.com

Product: Culligan Aquasential Smart High Efficiency 12" Softener-Clear Plus Water Conditioner

Testing Conditions & Results:

Flow Rate:	8.5 gpm @ 8 psi	Capacity:	28,365 grains @ 7.0 lb salt
Pressure:	30-40 psi		44,764 grains @ 16.0 lb salt
Acidity:	Non-Corrosive		58,658 grains @ 24.0 lb salt
Temperature:	68°F (20°C)	pH:	7.6
Efficiency Rated Dosage†:	4,052 gr/lb		

Softener Specifications:

Service Flow Rate:	8.5 gpm	Max. Drain Flow Rate:	3.5 gpm
Operating Temp. Range:	33-120°F (0-50°C)	Pressure Drop at Max. Flow Rate:	8 psi
Working Press. Range:	20-125 psi (140 - 860 kPa)	Oper. Press. Range (Canada):	20-90 psi (140 - 620 kPa)

Name of Substance	USEPA Max. Contaminant Level	pH	Flow Rate	Pressure
Barium	2.0 mg/L	7.5 + 0.5	8.5 gpm	8 (psig)
Radium 226/228	5 pCi/L	7.5 + 0.5	8.5 gpm	8 (psig)

This system is certified for barium and radium 226/228 reduction based on hardness reduction. It is recommended you test your water every six months to ensure the system is performing properly and that hardness, and therefore barium and radium 226/228, are being reduced. Hardness test strips have been included. Additional strips are available from your local Culligan dealer.

The Culligan Aquasential Smart High Efficiency 12" Softener-Clear Plus Water Conditioners have been tested and certified by WQA against CSA B483.1, NSF/ANSI Standard 372 for the low lead compliance, NSF/ANSI Standard 44 for the effective reduction of hardness (calcium and magnesium), barium, and radium 226/228, and NSF/ANSI 42 for the effective iron reduction up to 11 ppm, as verified and substantiated by test data.



An efficiency rated water softener is a DIR softener which also complies with specific performance specifications intended to minimize the amount of regenerant brine and water used in its operation. Efficiency rated water softeners shall have A rated salt efficiency of not less than 3350 grains of total hardness exchange per pound of salt (based on NaCl equivalency) (477 grams of total hardness exchange per kilogram of salt), and shall not deliver more salt than its listed rating. The efficiency is measured by a laboratory test described in NSF/ANSI 44. The test represents the maximum possible efficiency the system can achieve. Operational efficiency is the actual efficiency achieved after the system has been installed. It is typically less than the efficiency due to individual application factors including water hardness, water usage, and other contaminants that reduce the softener's capacity.

Dissolved Iron Reduction Testing Conditions and Results:

The Culligan Aquasential Smart High Efficiency 12" Softener-Clear Plus Water Conditioner has been tested according to NSF/ANSI standard 42 for effective reduction of iron up to 4,000 gallons with influent dissolved iron level up to 11 ppm. The claim is only valid for flow rate restricted to 8.5 gpm. The concentration of the indicated substances in water entering the system was reduced to a concentration less than or equal to the permissible limit for water leaving the system, as specified in NSF/ANSI 42.

Substance	Influent Challenge Concentration	Max Permissible Product Water Concentration	Flow Rate
Iron	9-11 mg/L	0.3 mg/L	8.5 gpm

Refer to the Specifications, Familiarization and Warranty section of this Owner's Guide (P/N 01040719) for more specific product information. To avoid contamination from improper handling and installation, your system should only be installed and serviced by your Culligan Man. Performance will vary based on local water conditions. The substances reduced by this system are not necessarily in your water.

Culligan water softeners are designed to work with any salt of good quality, although it is recommended that you ask your local Culligan dealer to suggest the best type and grade of salt to use in this softener.

NOTE! This softener is not intended to be used for treating water that is microbiologically unsafe or of unknown quality without adequate disinfection before or after the system.

† The efficiency rated dosage is only valid at the 7 lb salt dosage and maximum service flow rate for 12" models.

Culligan Aquasential Smart High Efficiency 14" Softener-Clear Plus Water Conditioner

Culligan knows the more informed you are about your water treatment systems, the more confident you will be about its performance. It's because of this and more than seventy years of commitment to customer satisfaction that Culligan is providing this Performance Data Sheet to its customers.

NOTE! Read this Performance Data Sheet and compare the capabilities of this unit with your actual water treatment needs. It is recommended that before purchasing a water treatment unit, you have your water supply tested to determine your actual water treatment needs.

Manufacturer: Culligan International Company
9399 W. Higgins Rd., Suite 1100
Rosemont, IL 60018 USA
(847) 430-2800
www.culligan.com

Product: Culligan Aquasential Smart High Efficiency 14" Softener-Clear Plus Water Conditioner

Testing Conditions & Results:

Flow Rate:	11.0 gpm @ 12 psi	Capacity:	42,548 grains @ 10.5 lb salt
Pressure:	30-40 psi		67,146 grains @ 24.0 lb salt
Acidity:	Non-Corrosive		87,987 grains @ 36.0 lb salt
Temperature:	68°F (20°C)	pH:	7.6
Efficiency Rated Dosage†:	4,052 gr/lb		

Softener Specifications:

Service Flow Rate:	11.0 gpm	Max. Drain Flow Rate:	5.28 gpm
Operating Temp. Range:	33-120°F (0-50°C)	Pressure Drop at Max. Flow Rate:	12 psi
Working Press. Range:	20-125 psi (140 - 860 kPa)	Oper. Press. Range (Canada):	20-90 psi (140 - 620 kPa)

Name of Substance	USEPA Max. Contaminant Level	pH	Flow Rate	Pressure
Barium	2.0 mg/L	7.5 + 0.5	11.0 gpm	12 (psig)
Radium 226/228	5 pCi/L	7.5 + 0.5	11.0 gpm	12 (psig)

This system is certified for barium and radium 226/228 reduction based on hardness reduction. It is recommended you test your water every six months to ensure the system is performing properly and that hardness, and therefore barium and radium 226/228, are being reduced. Hardness test strips have been included. Additional strips are available from your local Culligan dealer.

The Culligan Aquasential Smart High Efficiency 14" Softener-Clear Plus Water Conditioners have been tested and certified by WQA against CSA B483.1, NSF/ANSI Standard 372 for the low lead compliance, NSF/ANSI Standard 44 for the effective reduction of hardness (calcium and magnesium), barium, and radium 226/228, and NSF/ANSI 42 for the effective iron reduction up to 11 ppm, as verified and substantiated by test data.



An efficiency rated water softener is a DIR softener which also complies with specific performance specifications intended to minimize the amount of regenerated brine and water used in its operation. Efficiency rated water softeners shall have a rated salt efficiency of not less than 3350 grains of total hardness exchange per pound of salt (based on NaCl equivalency) (477 grams of total hardness exchange per kilogram of salt), and shall not deliver more salt than its listed rating. The efficiency is measured by a laboratory test described in NSF/ANSI 44. The test represents the maximum possible efficiency the system can achieve. Operational efficiency is the actual efficiency achieved after the system has been installed. It is typically less than the efficiency due to individual application factors including water hardness, water usage, and other contaminants that reduce the softener's capacity.

Dissolved Iron Reduction Testing Conditions and Results:

Culligan Aquasential Smart High Efficiency 14" Softener-Clear Plus Water Conditioner has been tested according to NSF/ANSI standard 42 for effective reduction of iron up to 6,000 gallons with influent dissolved iron level up to 11 ppm. The claim is only valid for flow rate restricted to 11 gpm. The concentration of the indicated substances in water entering the system was reduced to a concentration less than or equal to the permissible limit for water leaving the system, as specified in NSF/ANSI 42.

Substance	Influent Challenge Concentration	Max Permissible Product Water Concentration	Flow Rate
Iron	9-11 mg/L	0.3 mg/L	11 gpm

Refer to the Specifications, Familiarization and Warranty section of this Owner's Guide (P/N 01040719) for more specific product information. To avoid contamination from improper handling and installation, your system should only be installed and serviced by your Culligan Man. Performance will vary based on local water conditions. The substances reduced by this system are not necessarily in your water.

Culligan water softeners are designed to work with any salt of good quality, although it is recommended that you ask your local Culligan dealer to suggest the best type and grade of salt to use in this softener.

NOTE! This softener is not intended to be used for treating water that is microbiologically unsafe or of unknown quality without adequate disinfection before or after the system.

† The efficiency rated dosage is only valid at the 10.5 lb salt dosage and maximum service flow rate for 14" models.

Culligan Aquasential Smart High Efficiency Twin 9" and Twin 9" Outdoor Water Softener

Culligan knows the more informed you are about your water treatment systems, the more confident you will be about its performance. It's because of this and more than seventy years of commitment to customer satisfaction that Culligan is providing this Performance Data Sheet to its customers.

NOTE! Read this Performance Data Sheet and compare the capabilities of this unit with your actual water treatment needs. It is recommended that before purchasing a water treatment unit, you have your water supply tested to determine your actual water treatment needs.

Manufacturer: Culligan International Company
9399 W. Higgins Rd., Suite 1100
Rosemont, IL 60018 USA
(847) 430-2800
www.culligan.com

Product: Culligan Aquasential Smart High Efficiency Twin 9" and Twin 9" Outdoor Water Softener

Testing Conditions & Results:

Flow Rate:	9.0 gpm @ 11 psi	Capacity:	19,003 grains @ 4.0 lb salt
Pressure:	30–40 psi		25,823 grains @ 8.0 lb salt
Acidity:	Non-Corrosive		29,622 grains @ 12.0 lb salt
Temperature:	68°F (20°C)	pH:	7.6
Efficiency Rated Dosage†:	4,751 gr/lb		

Softener Specifications:

Service Flow Rate:	9.0 gpm	Pressure Drop at Max. Flow Rate:	11 psi
Operating Temp. Range:	33-120°F (1– 50°C)	Max. Drain Flow Rate:	1.98 gpm
Working Press. Range:	20–125 psi (140 - 860 kPa)	Oper. Press. Range (Canada):	20–90 psi (140 - 620 kPa)

Name of Substance	USEPA Max. Contaminant Level	pH	Flow Rate	Pressure
Barium	2.0 mg/L	7.5 + 0.5	9.0 gpm	11 (psig)
Radium 226/228	5 pCi/L	7.5 + 0.5	9.0 gpm	11 (psig)

This system is certified for barium and radium 226/228 reduction based on hardness reduction. It is recommended you test your water every 6 months to ensure the system is performing properly and that hardness, and therefore barium and radium 226/228, are being reduced.

The Culligan Aquasential Smart High Efficiency Twin 9" and Twin 9" Outdoor Water Softeners have been tested and certified by WQA against NSF/ANSI Standard 372, CSA B483.1, NSF/ANSI Standard 44 for the effective reduction of hardness (calcium and magnesium), barium, and radium 226/228, as verified and substantiated by test data. To maintain product certification and ensure uniform performance, the product is retested on a consistent basis.

An efficiency rated water softener is a DIR softener which also complies with specific performance specifications intended to minimize the amount of regenerant brine and water used in its operation. Efficiency rated water softeners shall have a rated salt efficiency of not less than 3350 grains of total hardness exchange per pound of salt (based on NaCl equivalency) (477 grams of total hardness exchange per kilogram of salt), and shall not deliver more salt than its listed rating. The efficiency is measured by a laboratory test described in NSF/ANSI 44. The test represents the maximum possible efficiency the system can achieve. Operational efficiency is the actual efficiency achieved after the system has been installed. It is typically less than the efficiency due to individual application factors including water hardness, water usage, and other contaminants that reduce the softener's capacity.

Refer to the Specifications, Familiarization and Warranty section of this Owner's Guide (P/N 01040719) for more specific product information. To avoid contamination from improper handling and installation, your system should only be installed and serviced by your Culligan Man. Performance will vary based on local water conditions. The substances reduced by this system are not necessarily in your water.

Culligan water softeners are designed to work with any salt of good quality, although it is recommended that you ask your local Culligan dealer for his suggestion on the best type and grade of salt to use in this softener.

NOTE! This softener is not intended to be used for treating water that is microbiologically unsafe or of unknown quality without adequate disinfection before or after the system.

† The efficiency rated dosage is only valid at the 4 lb salt dosage and maximum service flow rate for 9" models.



Culligan Aquasential Smart High Efficiency Twin 10" and Twin 10" Outdoor Water Softener

Culligan knows the more informed you are about your water treatment systems, the more confident you will be about its performance. It's because of this and more than seventy years of commitment to customer satisfaction that Culligan is providing this Performance Data Sheet to its customers.

NOTE! Read this Performance Data Sheet and compare the capabilities of this unit with your actual water treatment needs. It is recommended that before purchasing a water treatment unit, you have your water supply tested to determine your actual water treatment needs.

Manufacturer: Culligan International Company
9399 W. Higgins Rd., Suite 1100
Rosemont, IL 60018 USA
(847) 430-2800
www.culligan.com

Product: Culligan Aquasential Smart High Efficiency Twin 10" and Twin 10" Outdoor Water Softener

Testing Conditions & Results:

Flow Rate:	9.4 gpm @ 12 psi	Capacity:	30,439 grains @ 6.0 lb salt
Pressure:	30–40 psi		45,609 grains @ 12.0 lb salt
Acidity:	Non-Corrosive		48,623 grains @ 18.0 lb salt
Temperature:	68°F (20°C)	pH:	7.6
Efficiency Rated Dosage†:	5,073 gr/lb		

Softener Specifications:

Service Flow Rate:	9.4 gpm	Pressure Drop at Max. Flow Rate:	12 psi
Operating Temp. Range:	33-120°F (1–50°C)	Max. Drain Flow Rate:	2.0 gpm
Working Press. Range:	20–125 psi (140 - 860 kPa)	Oper. Press. Range (Canada):	20–90 psi (140 - 620 kPa)

Name of Substance	USEPA Max. Contaminant Level	pH	Flow Rate	Pressure
Barium	2.0 mg/L	7.5 + 0.5	9.4 gpm	12 (psig)
Radium 226/228	5 pCi/L	7.5 + 0.5	9.4 gpm	12 (psig)

This system is certified for barium and radium 226/228 reduction based on hardness reduction. It is recommended you test your water every 6 months to ensure the system is performing properly and that hardness, and therefore barium and radium 226/228, are being reduced.

The Culligan Aquasential Smart High Efficiency Twin 10" and Twin 10" Outdoor Water Softeners have been tested and certified by WQA against NSF/ANSI Standard 372, CSA B483.1, and NSF/ANSI Standard 44 for the effective reduction of hardness (calcium and magnesium), barium, and radium 226/228, as verified and substantiated by test data. To maintain product certification and ensure uniform performance, the product is retested on a consistent basis.

An efficiency rated water softener is a DIR softener which also complies with specific performance specifications intended to minimize the amount of regenerant brine and water used in its operation. Efficiency rated water softeners shall have a rated salt efficiency of not less than 3350 grains of total hardness exchange per pound of salt (based on NaCl equivalency) (477 grams of total hardness exchange per kilogram of salt), and shall not deliver more salt than its listed rating. The efficiency is measured by a laboratory test described in NSF/ANSI 44. The test represents the maximum possible efficiency the system can achieve. Operational efficiency is the actual efficiency achieved after the system has been installed. It is typically less than the efficiency due to individual application factors including water hardness, water usage, and other contaminants that reduce the softener's capacity.

Refer to the Specifications, Familiarization and Warranty section of this Owner's Guide (P/N 01040719) for more specific product information. To avoid contamination from improper handling and installation, your system should only be installed and serviced by your Culligan Man. Performance will vary based on local water conditions. The substances reduced by this system are not necessarily in your water.

Culligan water softeners are designed to work with any salt of good quality, although it is recommended that you ask your local Culligan dealer for his suggestion on the best type and grade of salt to use in this softener.

NOTE! This softener is not intended to be used for treating water that is microbiologically unsafe or of unknown quality without adequate disinfection before or after the system.

† The efficiency rated dosage is only valid at the 6 lb salt dosage and maximum service flow rate for 10" models.



Culligan Aquasential Smart High Efficiency Twin 12" and Twin 12" Outdoor Water Softener

Culligan knows the more informed you are about your water treatment systems, the more confident you will be about its performance. It's because of this and more than seventy years of commitment to customer satisfaction that Culligan is providing this Performance Data Sheet to its customers.

NOTE! Read this Performance Data Sheet and compare the capabilities of this unit with your actual water treatment needs. It is recommended that before purchasing a water treatment unit, you have your water supply tested to determine your actual water treatment needs.

Manufacturer: Culligan International Company
9399 W. Higgins Rd., Suite 1100
Rosemont, IL 60018 USA
(847) 430-2800
www.culligan.com

Product: Culligan Aquasential Smart High Efficiency Twin 12" and Twin 12" Outdoor Water Softener

Testing Conditions & Results:

Flow Rate:	10.0 gpm @ 11 psi	Capacity:	28,365 grains @ 7.0 lb salt
Pressure:	30–40 psi		44,764 grains @ 16.0 lb salt
Acidity:	Non-Corrosive		58,658 grains @ 24.0 lb salt
Temperature:	68°F (20°C)	pH:	7.6
Efficiency Rated Dosage†:	4,052 gr/lb		

Softener Specifications:

Service Flow Rate:	10.0 gpm	Pressure Drop at Max. Flow Rate:	11 psi
Operating Temp. Range:	33-120°F (1–50°C)	Max. Drain Flow Rate:	2.79 gpm
Working Press. Range:	20–125 psi (140 - 860 kPa)	Oper. Press. Range (Canada):	20–90 psi (140 - 620 kPa)

Name of Substance	USEPA Max. Contaminant Level	pH	Flow Rate	Pressure
Barium	2.0 mg/L	7.5 + 0.5	10.0 gpm	11 (psig)
Radium 226/228	5 pCi/L	7.5 + 0.5	10.0 gpm	11 (psig)

This system is certified for barium and radium 226/228 reduction based on hardness reduction. It is recommended you test your water every 6 months to ensure the system is performing properly and that hardness, and therefore barium and radium 226/228, are being reduced.

The Culligan Aquasential Smart High Efficiency Twin 12" and Twin 12" Outdoor Water Softeners have been tested and certified by WQA against NSF/ANSI Standard 372, CSA B483.1, and NSF/ANSI Standard 44 for the effective reduction of hardness (calcium and magnesium), barium, and radium 226/228, as verified and substantiated by test data. To maintain product certification and ensure uniform performance, the product is retested on a consistent basis.



An efficiency rated water softener is a DIR softener which also complies with specific performance specifications intended to minimize the amount of regenerant brine and water used in its operation. Efficiency rated water softeners shall have a rated salt efficiency of not less than 3350 grains of total hardness exchange per pound of salt (based on NaCl equivalency) (477 grams of total hardness exchange per kilogram of salt), and shall not deliver more salt than its listed rating. The efficiency is measured by a laboratory test described in NSF/ANSI 44. The test represents the maximum possible efficiency the system can achieve. Operational efficiency is the actual efficiency achieved after the system has been installed. It is typically less than the efficiency due to individual application factors including water hardness, water usage, and other contaminants that reduce the softener's capacity.

Refer to the Specifications, Familiarization and Warranty section of this Owner's Guide (P/N 01040719) for more specific product information. To avoid contamination from improper handling and installation, your system should only be installed and serviced by your Culligan Man. Performance will vary based on local water conditions. The substances reduced by this system are not necessarily in your water.

Culligan water softeners are designed to work with any salt of good quality, although it is recommended that you ask your local Culligan dealer for his suggestion on the best type and grade of salt to use in this softener.

NOTE! This softener is not intended to be used for treating water that is microbiologically unsafe or of unknown quality without adequate disinfection before or after the system.

† The efficiency rated dosage is only valid at the 7 lb salt dosage and maximum service flow rate for 12" models.

Culligan Aquasential Smart High Efficiency Twin 14" and Twin 14" Outdoor Water Softener

Culligan knows the more informed you are about your water treatment systems, the more confident you will be about its performance. It's because of this and more than seventy years of commitment to customer satisfaction that Culligan is providing this Performance Data Sheet to its customers.

NOTE! Read this Performance Data Sheet and compare the capabilities of this unit with your actual water treatment needs. It is recommended that before purchasing a water treatment unit, you have your water supply tested to determine your actual water treatment needs.

Manufacturer: Culligan International Company
9399 W. Higgins Rd., Suite 1100
Rosemont, IL 60018 USA
(847) 430-2800
www.culligan.com

Product: Culligan Aquasential Smart High Efficiency Twin 14" and Twin 14" Outdoor Water Softener

Testing Conditions & Results:

Flow Rate:	10.6 gpm @ 11 psi	Capacity:	42,548 grains @ 10.5 lb salt
Pressure:	30–40 psi		67,146 grains @ 24.0 lb salt
Acidity:	Non-Corrosive		87,987 grains @ 36.0 lb salt
Temperature:	68°F (20°C)	pH:	7.6
Efficiency Rated Dosage†:	4,052 gr/lb		

Softener Specifications:

Service Flow Rate:	10.6 gpm	Pressure Drop at Max. Flow Rate:	11 psi
Operating Temp. Range:	33–120°F (1–50°C)	Max. Drain Flow Rate:	5.28 gpm
Working Press. Range:	20–125 psi (140 - 860 kPa)	Oper. Press. Range (Canada):	20–90 psi (140 - 620 kPa)

Name of Substance	USEPA Max. Contaminant Level	pH	Flow Rate	Pressure
Barium	2.0 mg/L	7.5 + 0.5	10.6 gpm	11 (psig)
Radium 226/228	5 pCi/L	7.5 + 0.5	10.6 gpm	11 (psig)

This system is certified for barium and radium 226/228 reduction based on hardness reduction. It is recommended you test your water every 6 months to ensure the system is performing properly and that hardness, and therefore barium and radium 226/228, are being reduced.

The Culligan Aquasential Smart High Efficiency Twin 14" and Twin 14" Outdoor Water Softeners have been tested and certified by WQA against NSF/ANSI Standard 372, CSA B483.1, and NSF/ANSI Standard 44 for the effective reduction of hardness (calcium and magnesium), barium, and radium 226/228, as verified and substantiated by test data. To maintain product certification and ensure uniform performance, the product is retested on a consistent basis.

An efficiency rated water softener is a DIR softener which also complies with specific performance specifications intended to minimize the amount of regenerant brine and water used in its operation. Efficiency rated water softeners shall have a rated salt efficiency of not less than 3350 grains of total hardness exchange per pound of salt (based on NaCl equivalency) (477 grams of total hardness exchange per kilogram of salt), and shall not deliver more salt than its listed rating. The efficiency is measured by a laboratory test described in NSF/ANSI 44. The test represents the maximum possible efficiency the system can achieve. Operational efficiency is the actual efficiency achieved after the system has been installed. It is typically less than the efficiency due to individual application factors including water hardness, water pH, and other contaminants that reduce the softener's capacity.

Refer to the Specifications, Familiarization and Warranty section of this Owner's Guide (P/N 01040719) for more specific product information. To avoid contamination from improper handling and installation, your system should only be installed and serviced by your Culligan Man. Performance will vary based on local water conditions. The substances reduced by this system are not necessarily in your water.

Culligan water softeners are designed to work with any salt of good quality, although it is recommended that you ask your local Culligan dealer for his suggestion on the best type and grade of salt to use in this softener.

NOTE! This softener is not intended to be used for treating water that is microbiologically unsafe or of unknown quality without adequate disinfection before or after the system.

† The efficiency rated dosage is only valid at the 10.5 lb salt dosage and maximum service flow rate for 14" models.



Culligan Aquasential Smart High Efficiency Twin Upflow 9" Water Softener

Culligan knows the more informed you are about your water treatment systems, the more confident you will be about its performance. It's because of this and more than seventy years of commitment to customer satisfaction that Culligan is providing this Performance Data Sheet to its customers.

NOTE! Read this Performance Data Sheet and compare the capabilities of this unit with your actual water treatment needs. It is recommended that before purchasing a water treatment unit, you have your water supply tested to determine your actual water treatment needs.

Manufacturer: Culligan International Company
9399 W. Higgins Rd., Suite 1100
Rosemont, IL 60018 USA
(847) 430-2800
www.culligan.com

Product: Culligan Aquasential Smart High Efficiency Twin Upflow 9" Water Softener

Testing Conditions & Results:

Flow Rate:	9.0 gpm @ 15 psi	Capacity:	10,209 grains @ 2.0 lb salt
Pressure:	30–40 psi		16,666 grains @ 4.0 lb salt
Acidity:	Non-Corrosive		25,116 grains @ 8.0 lb salt
Temperature:	68°F (20°C)	pH:	7.6
Efficiency Rated Dosage†:	5,105 gr/lb		

Softener Specifications:

Service Flow Rate:	9.0 gpm	Pressure Drop at Max. Flow Rate:	15 psi
Operating Temp. Range:	33-120°F (1–50°C)	Max. Drain Flow Rate:	1.98 gpm
Working Press. Range:	20–125 psi (140 - 860 kPa)	Oper. Press. Range (Canada):	20–90 psi (140 - 620 kPa)

Name of Substance	USEPA Max. Contaminant Level	pH	Flow Rate	Pressure
Barium	2.0 mg/L	7.5 + 0.5	9.0 gpm	15 (psig)
Radium 226/228	5 pCi/L	7.5 + 0.5	9.0 gpm	15 (psig)

This system is certified for barium and radium 226/228 reduction based on hardness reduction. It is recommended you test your water every 6 months to ensure the system is performing properly and that hardness, and therefore barium and radium 226/228, are being reduced.

The Culligan Aquasential Smart High Efficiency Twin Upflow 9" Water Softeners have been tested and certified by WQA against NSF/ANSI Standard 372, CSA B483.1, and NSF/ANSI Standard 44 for the effective reduction of hardness (calcium and magnesium), barium, and radium 226/228, as verified and substantiated by test data. To maintain product certification and ensure uniform performance, the product is retested on a consistent basis.

An efficiency rated water softener is a DIR softener which also complies with specific performance specifications intended to minimize the amount of regenerant brine and water used in its operation. Efficiency rated water softeners shall have a rated salt efficiency of not less than 3350 grains of total hardness exchange per pound of salt (based on NaCl equivalency) (477 grams of total hardness exchange per kilogram of salt), and shall not deliver more salt than its listed rating. The efficiency is measured by a laboratory test described in NSF/ANSI 44. The test represents the maximum possible efficiency the system can achieve. Operational efficiency is the actual efficiency achieved after the system has been installed. It is typically less than the efficiency due to individual application factors including water hardness, water usage, and other contaminants that reduce the softener's capacity.

Refer to the Specifications, Familiarization and Warranty section of this Owner's Guide (P/N 01040719) for more specific product information. To avoid contamination from improper handling and installation, your system should only be installed and serviced by your Culligan Man. Performance will vary based on local water conditions. The substances reduced by this system are not necessarily in your water.

Culligan water softeners are designed to work with any salt of good quality, although it is recommended that you ask your local Culligan dealer for his suggestion on the best type and grade of salt to use in this softener.

NOTE! This softener is not intended to be used for treating water that is microbiologically unsafe or of unknown quality without adequate disinfection before or after the system.

† The efficiency rated dosage is only valid at the 2 lb salt dosage and maximum service flow rate for 9" models.



Culligan Aquasential Smart High Efficiency Twin Upflow 10" Water Softener

Culligan knows the more informed you are about your water treatment systems, the more confident you will be about its performance. It's because of this and more than seventy years of commitment to customer satisfaction that Culligan is providing this Performance Data Sheet to its customers.

NOTE! Read this Performance Data Sheet and compare the capabilities of this unit with your actual water treatment needs. It is recommended that before purchasing a water treatment unit, you have your water supply tested to determine your actual water treatment needs.

Manufacturer: Culligan International Company
9399 W. Higgins Rd., Suite 1100
Rosemont, IL 60018 USA
(847) 430-2800
www.culligan.com

Product: Culligan Aquasential Smart High Efficiency Twin Upflow 10" Water Softener

Testing Conditions & Results:

Flow Rate:	9.1 gpm @ 15 psi	Capacity:	15,314 grains @ 3.0 lb salt
Pressure:	30–40 psi		24,999 grains @ 6.0 lb salt
Acidity:	Non-Corrosive		37,674 grains @ 12.0 lb salt
Temperature:	68°F (20°C)	pH:	7.6
Efficiency Rated Dosage†:	5,105 gr/lb		

Softener Specifications:

Service Flow Rate:	9.4 gpm	Pressure Drop at Max. Flow Rate:	15 psi
Operating Temp. Range:	33-120°F (1–50°C)	Max. Drain Flow Rate:	1.98 gpm
Working Press. Range:	20–125 psi (140 - 860 kPa)	Oper. Press. Range (Canada):	20–90 psi (140 - 620 kPa)

Name of Substance	USEPA Max. Contaminant Level	pH	Flow Rate	Pressure
Barium	2.0 mg/L	7.5 + 0.5	9.1 gpm	15 (psig)
Radium 226/228	5 pCi/L	7.5 + 0.5	9.1 gpm	15 (psig)

This system is certified for barium and radium 226/228 reduction based on hardness reduction. It is recommended you test your water every 6 months to ensure the system is performing properly and that hardness, and therefore barium and radium 226/228, are being reduced.

The Culligan Aquasential Smart High Efficiency Twin Upflow 10" Water Softeners have been tested and certified by WQA against NSF/ANSI Standard 372, CSA B483.1, and NSF/ANSI Standard 44 for the effective reduction of hardness (calcium and magnesium), barium, and radium 226/228, as verified and substantiated by test data. To maintain product certification and ensure uniform performance, the product is retested on a consistent basis.



An efficiency rated water softener is a DIR softener which also complies with specific performance specifications intended to minimize the amount of regenerant brine and water used in its operation. Efficiency rated water softeners shall have a rated salt efficiency of not less than 3350 grains of total hardness exchange per pound of salt (based on NaCl equivalency) (477 grams of total hardness exchange per kilogram of salt), and shall not deliver more salt than its listed rating. The efficiency is measured by a laboratory test described in NSF/ANSI 44. The test represents the maximum possible efficiency the system can achieve. Operational efficiency is the actual efficiency achieved after the system has been installed. It is typically less than the efficiency due to individual application factors including water hardness, water usage, and other contaminants that reduce the softener's capacity.

Refer to the Specifications, Familiarization and Warranty section of this Owner's Guide (P/N 01040719) for more specific product information. To avoid contamination from improper handling and installation, your system should only be installed and serviced by your Culligan Man. Performance will vary based on local water conditions. The substances reduced by this system are not necessarily in your water.

Culligan water softeners are designed to work with any salt of good quality, although it is recommended that you ask your local Culligan dealer for his suggestion on the best type and grade of salt to use in this softener.

NOTE! This softener is not intended to be used for treating water that is microbiologically unsafe or of unknown quality without adequate disinfection before or after the system.

† The efficiency rated dosage is only valid at the 3 lb salt dosage and maximum service flow rate for 10" models.

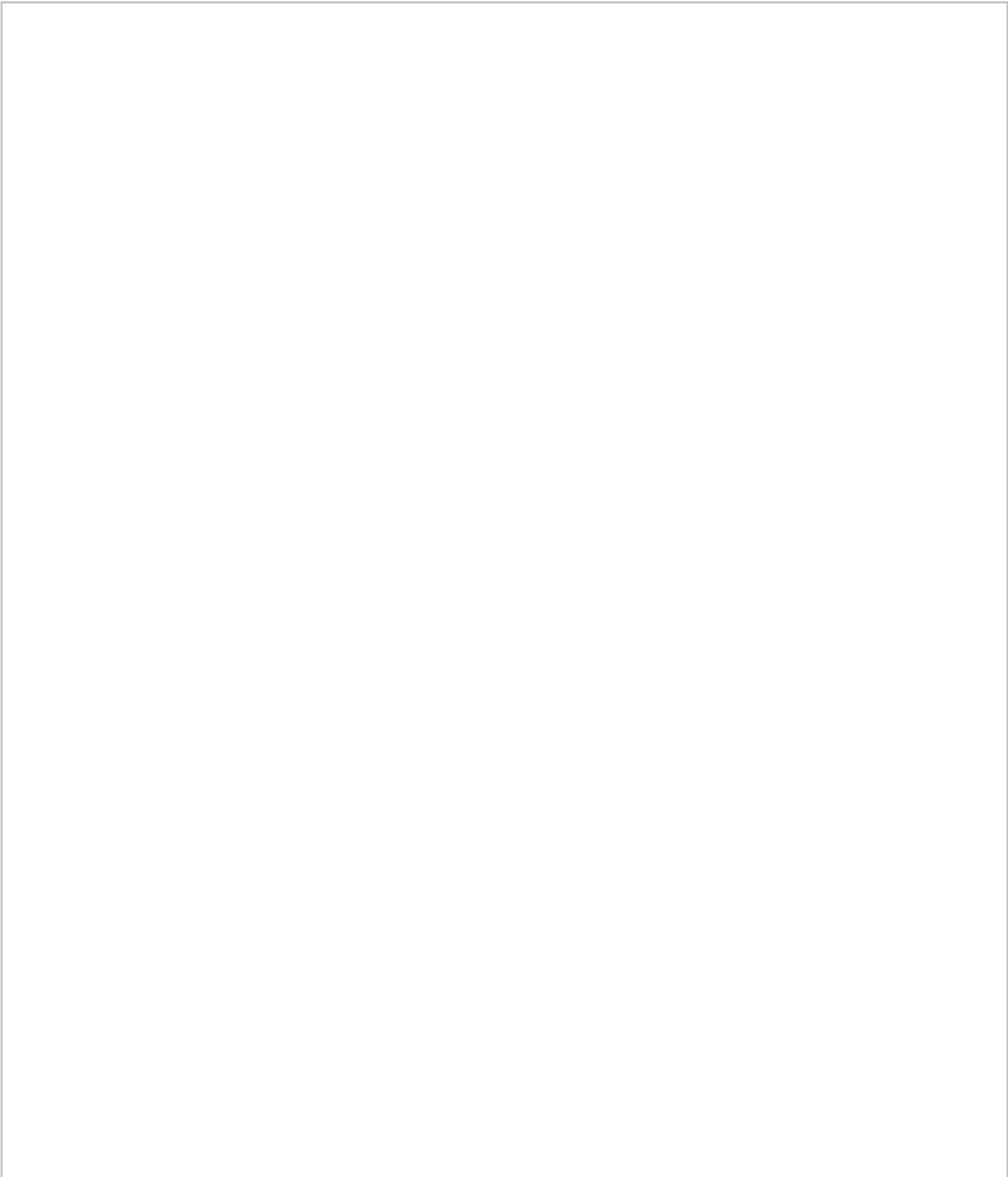

THIS PAGE INTENTIONALLY LEFT BLANK

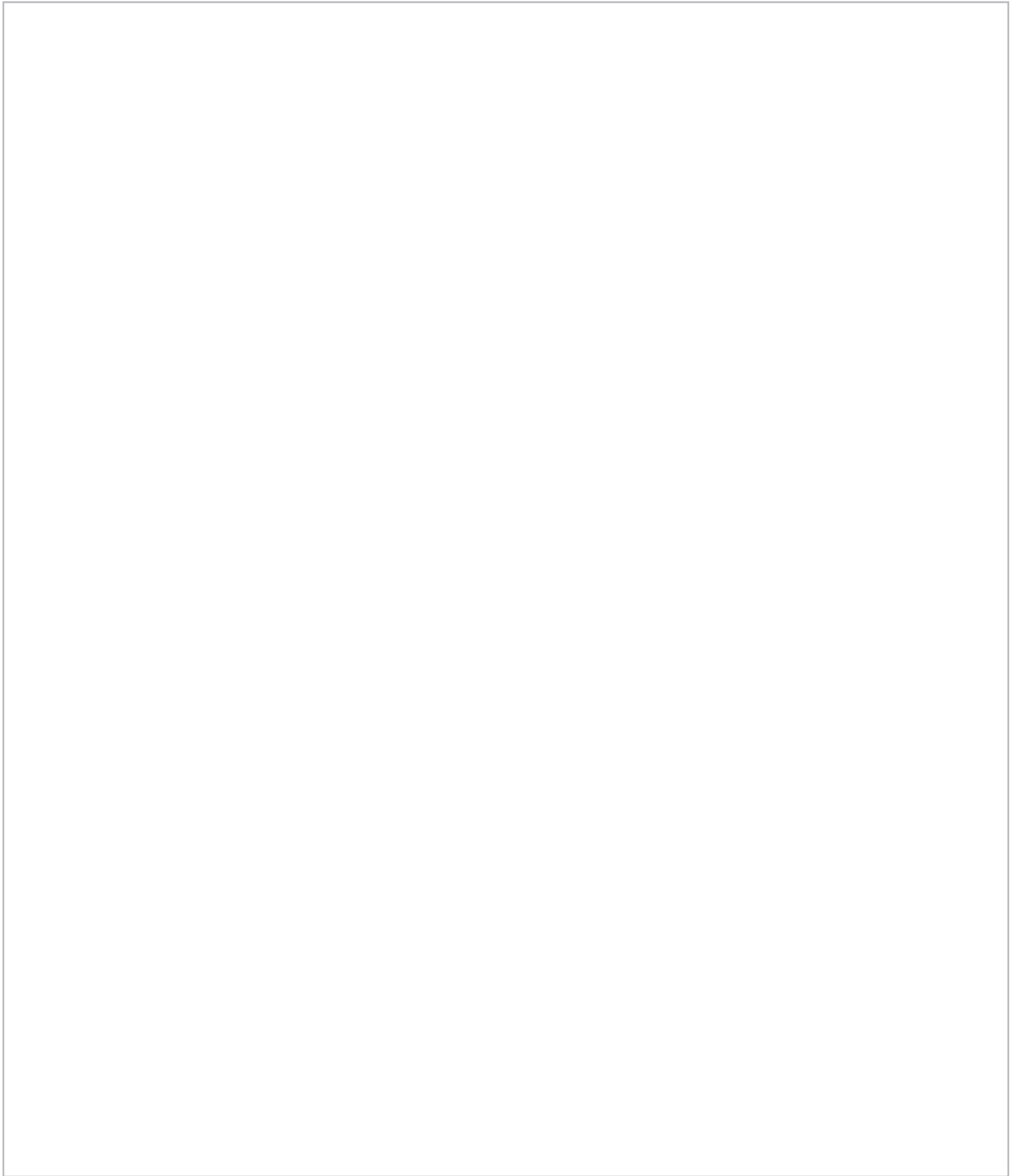

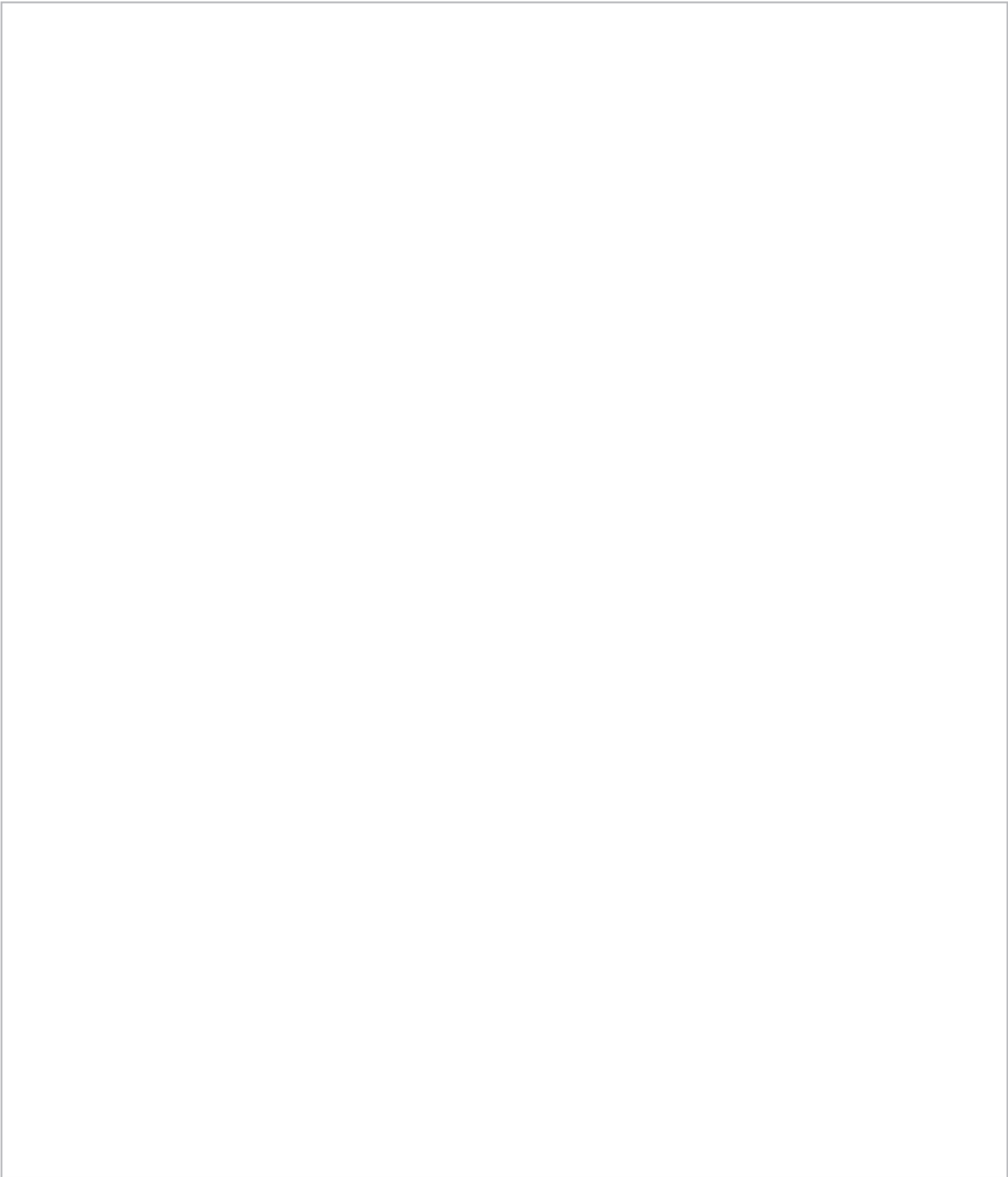

Culligan Aquasential Smart High Efficiency Water Softener Model: HE-1.25-10

Culligan knows the more informed you are about your water treatment systems, the more confident you will be about its performance. It's because of this and more than seventy years of commitment to customer satisfaction that Culligan is providing this Performance Data Sheet to its customers.

NOTE! Read this Performance Data Sheet and compare the capabilities of this unit with your actual water treatment needs. It is recommended that before purchasing a water treatment unit, you have your water supply tested to determine your actual water treatment needs.

Manufacturer: Culligan International Company
9399 W. Higgins Rd., Suite 1100
Rosemont, IL 60018 USA
(847) 430-2800
www.culligan.com

Product: Culligan Aquasential Smart High Efficiency Water Softener Model: HE-1.25-10

Testing Conditions & Results:

Flow Rate:	14.9 gpm @ 14 psi	Capacity:	29,764 grains @ 6.0 lb salt
Pressure:	30–40 psi		43,505 grains @ 12.0 lb salt
Acidity:	Non-Corrosive		51,353 grains @ 18.0 lb salt
Temperature:	68°F (20°C)	pH:	7.6
Efficiency Rated Dosage†:	4,961 gr/lb		

Softener Specifications:

Service Flow Rate:	14.9 gpm	Pressure Drop at Max. Flow Rate:	14 psi
Operating Temp. Range:	33–120°F (1–50°C)	Max. Drain Flow Rate:	2.38 gpm
Working Press. Range:	20–125 psi (140 - 860 kPa)	Oper. Press. Range (Canada):	20–90 psi (140 - 620 kPa)

Name of Substance	USEPA Max. Contaminant Level	pH	Flow Rate	Pressure
Barium	2.0 mg/L	7.5 + 0.5	14.9 gpm	14 (psig)
Radium 226/228	5 pCi/L	7.5 + 0.5	14.9 gpm	14 (psig)

This system is certified for barium and radium 226/228 reduction based on hardness reduction. It is recommended you test your water every six months to ensure the system is performing properly and that hardness, and therefore barium and radium 226/228, are being reduced. Hardness test strips have been included. Additional strips are available from your local Culligan dealer.

The Culligan Aquasential Smart High Efficiency Water Softener Model: HE-1.25-10 has been tested and certified by WQA against NSF/ANSI Standard 372, CSA B483.1, and NSF/ANSI Standard 44 for the effective reduction of hardness (calcium and magnesium), barium, and radium 226/228 as verified and substantiated by test data. To maintain product certification and ensure uniform performance, the product is retested on a consistent basis.



An efficiency rated water softener is a DIR softener which also complies with specific performance specifications intended to minimize the amount of regenerant brine and water used in its operation. Efficiency rated water softeners shall have a rated salt efficiency of not less than 3350 grains of total hardness exchange per pound of salt (based on NaCl equivalency) (477 grams of total hardness exchange per kilogram of salt), and shall not deliver more salt than its listed rating. The efficiency is measured by a laboratory test described in NSF/ANSI 44. The test represents the maximum possible efficiency the system can achieve. Operational efficiency is the actual efficiency achieved after the system has been installed. It is typically less than the efficiency due to individual application factors including water hardness, water usage, and other contaminants that reduce the softener's capacity.

Refer to the Specifications, Familiarization and Warranty section of this Owner's Guide (P/N 01040719) for more specific product information. To avoid contamination from improper handling and installation, your system should only be installed and serviced by your Culligan dealer. Performance will vary based on local water conditions. The substances reduced by this system are not necessarily in your water.

Culligan water softeners are designed to work with any salt of good quality, although it is recommended that you ask your local Culligan dealer for his suggestion on the best type and grade of salt to use in this softener.

NOTE! This softener is not intended to be used for treating water that is microbiologically unsafe or of unknown quality without adequate disinfection before or after the system.

† The efficiency rated dosage is only valid at the 6 lb salt dosage and maximum service flow rate for 10" models.

Culligan Aquasential Smart High Efficiency Water Softener Model: HE-1.25-12

Culligan knows the more informed you are about your water treatment systems, the more confident you will be about its performance. It's because of this and more than seventy years of commitment to customer satisfaction that Culligan is providing this Performance Data Sheet to its customers.

NOTE! Read this Performance Data Sheet and compare the capabilities of this unit with your actual water treatment needs. It is recommended that before purchasing a water treatment unit, you have your water supply tested to determine your actual water treatment needs.

Manufacturer: Culligan International Company
9399 W. Higgins Rd., Suite 1100
Rosemont, IL 60018 USA
(847) 430-2800
www.culligan.com

Product: Culligan Aquasential Smart High Efficiency Water Softener Model: HE-1.25-12

Testing Conditions & Results:

Flow Rate:	17.9 gpm @ 15 psi	Capacity:	35,027 grains @ 8.0 lb salt
Pressure:	30–40 psi		52,874 grains @ 16.0 lb salt
Acidity:	Non-Corrosive		61,235 grains @ 24.0 lb salt
Temperature:	68°F (20°C)	pH:	7.6
Efficiency Rated Dosage†:	4,378 gr/lb		

Softener Specifications:

Service Flow Rate:	17.9 gpm	Pressure Drop at Max. Flow Rate:	15 psi
Operating Temp. Range:	33–120°F (1–50°C)	Max. Drain Flow Rate:	3.88 gpm
Working Press. Range:	20–125 psi (140 - 860 kPa)	Oper. Press. Range (Canada):	20–90 psi (140 - 620 kPa)

Name of Substance	USEPA Max. Contaminant Level	pH	Flow Rate	Pressure
Barium	2.0 mg/L	7.5 + 0.5	17.9 gpm	15 (psig)
Radium 226/228	5 pCi/L	7.5 + 0.5	17.9 gpm	15 (psig)

This system is certified for barium and radium 226/228 reduction based on hardness reduction. It is recommended you test your water every six months to ensure the system is performing properly and that hardness, and therefore barium and radium 226/228, are being reduced. Hardness test strips have been included. Additional strips are available from your local Culligan dealer.

The Culligan Aquasential Smart High Efficiency Water Softener Model: HE-1.25-12 has been tested and certified by WQA against NSF/ANSI Standard 372, CSA B483.1, and NSF/ANSI Standard 44 for the effective reduction of hardness (calcium and magnesium), barium, and radium 226/228 as verified and substantiated by test data. To maintain product certification and ensure uniform performance, the product is retested on a consistent basis.



An efficiency rated water softener is a DIR softener which also complies with specific performance specifications intended to minimize the amount of regenerant brine and water used in its operation. Efficiency rated water softeners shall have a rated salt efficiency of not less than 3350 grains of total hardness exchange per pound of salt (based on NaCl equivalency) (477 grams of total hardness exchange per kilogram of salt), and shall not deliver more salt than its listed rating. The efficiency is measured by a laboratory test described in NSF/ANSI 44. The test represents the maximum possible efficiency the system can achieve. Operational efficiency is the actual efficiency achieved after the system has been installed. It is typically less than the efficiency due to individual application factors including water hardness, water usage, and other contaminants that reduce the softener's capacity.

Refer to the Specifications, Familiarization and Warranty section of this Owner's Guide (P/N 01040719) for more specific product information. To avoid contamination from improper handling and installation, your system should only be installed and serviced by your Culligan dealer. Performance will vary based on local water conditions. The substances reduced by this system are not necessarily in your water.

Culligan water softeners are designed to work with any salt of good quality, although it is recommended that you ask your local Culligan dealer for his suggestion on the best type and grade of salt to use in this softener.

NOTE! This softener is not intended to be used for treating water that is microbiologically unsafe or of unknown quality without adequate disinfection before or after the system.

† The efficiency rated dosage is only valid at the 8 lb salt dosage and maximum service flow rate for 12" models.

Culligan Aquasential Smart High Efficiency Water Softener Model: HE-1.25-14

Culligan knows the more informed you are about your water treatment systems, the more confident you will be about its performance. It's because of this and more than seventy years of commitment to customer satisfaction that Culligan is providing this Performance Data Sheet to its customers.

NOTE! Read this Performance Data Sheet and compare the capabilities of this unit with your actual water treatment needs. It is recommended that before purchasing a water treatment unit, you have your water supply tested to determine your actual water treatment needs.

Manufacturer: Culligan International Company
9399 W. Higgins Rd., Suite 1100
Rosemont, IL 60018 USA
(847) 430-2800
www.culligan.com

Product: Culligan Aquasential Smart High Efficiency Water Softener Model: HE-1.25-14

Testing Conditions & Results:

Flow Rate:	19.3 gpm @ 15 psi	Capacity:	52,541 grains @ 12.0 lb salt
Pressure:	30–40 psi		79,311 grains @ 24.0 lb salt
Acidity:	Non-Corrosive		91,853 grains @ 36.0 lb salt
Temperature:	68°F (20°C)	pH:	7.6
Efficiency Rated Dosage†:	4,378 gr/lb		

Softener Specifications:

Service Flow Rate:	19.3 gpm	Pressure Drop at Max. Flow Rate:	15 psi (71 kPa)
Operating Temp. Range:	33–120°F (1–50°C)	Max. Drain Flow Rate:	5.5 gpm
Working Press. Range:	20–125 psi (140 - 860 kPa)	Oper. Press. Range (Canada):	20–90 psi (140 - 620 kPa)

Name of Substance	USEPA Max. Contaminant Level	pH	Flow Rate	Pressure
Barium	2.0 mg/L	7.5 + 0.5	19.3 gpm	15 (psig)
Radium 226/228	5 pCi/L	7.5 + 0.5	19.3 gpm	15 (psig)

This system is certified for barium and radium 226/228 reduction based on hardness reduction. It is recommended you test your water every six months to ensure the system is performing properly and that hardness, and therefore barium and radium 226/228, are being reduced. Hardness test strips have been included. Additional strips are available from your local Culligan dealer.

The Culligan Aquasential Smart High Efficiency Water Softener Model: HE-1.25-14 has been tested and certified by WQA against NSF/ANSI Standard 372, CSAB483.1, and NSF/ANSI Standard 44 for the effective reduction of hardness (calcium and magnesium), barium, and radium 226/228 as verified and substantiated by test data. To maintain product certification and ensure uniform performance, the product is retested on a consistent basis.



An efficiency rated water softener is a DIR softener which also complies with specific performance specifications intended to minimize the amount of regenerant brine and water used in its operation. Efficiency rated water softeners shall have a rated salt efficiency of not less than 3350 grains of total hardness exchange per pound of salt (based on NaCl equivalency) (477 grams of total hardness exchange per kilogram of salt), and shall not deliver more salt than its listed rating. The efficiency is measured by a laboratory test described in NSF/ANSI 44. The test represents the maximum possible efficiency the system can achieve. Operational efficiency is the actual efficiency achieved after the system has been installed. It is typically less than the efficiency due to individual application factors including water hardness, water usage, and other contaminants that reduce the softener's capacity.

Refer to the Specifications, Familiarization and Warranty section of this Owner's Guide (P/N 01040719) for more specific product information. To avoid contamination from improper handling and installation, your system should only be installed and serviced by your Culligan dealer. Performance will vary based on local water conditions. The substances reduced by this system are not necessarily in your water.

Culligan water softeners are designed to work with any salt of good quality, although it is recommended that you ask your local Culligan dealer for his suggestion on the best type and grade of salt to use in this softener.

NOTE! This softener is not intended to be used for treating water that is microbiologically unsafe or of unknown quality without adequate disinfection before or after the system.

† The efficiency rated dosage is only valid at the 12 lb salt dosage and maximum service flow rate for 14" models.

Culligan Aquasential Smart High Efficiency Water Softener Model: HE-1.25-16

Culligan knows the more informed you are about your water treatment systems, the more confident you will be about its performance. It's because of this and more than seventy years of commitment to customer satisfaction that Culligan is providing this Performance Data Sheet to its customers.

NOTE! Read this Performance Data Sheet and compare the capabilities of this unit with your actual water treatment needs. It is recommended that before purchasing a water treatment unit, you have your water supply tested to determine your actual water treatment needs.

Manufacturer: Culligan International Company
9399 W. Higgins Rd., Suite 1100
Rosemont, IL 60018 USA
(847) 430-2800
www.culligan.com

Product: Culligan Aquasential Smart High Efficiency Water Softener Model: HE-1.25-16

Testing Conditions & Results:

Flow Rate:	21.0 gpm @ 15 psi	Capacity:	70,054 grains @ 16.0 lb salt
Pressure:	30–40 psi		105,748 grains @ 32.0 lb salt
Acidity:	Non-Corrosive		122,470 grains @ 48.0 lb salt
Temperature:	68°F (20°C)	pH:	7.6
Efficiency Rated Dosage†:	4,378 gr./lb		

Softener Specifications:

Service Flow Rate:	21.0 gpm	Pressure Drop at Max. Flow Rate:	15 psi
Operating Temp. Range:	33–120°F (1–50°C)	Max. Drain Flow Rate:	5.5 gpm
Working Press. Range:	20–125 psi (140 - 860 kPa)	Oper. Press. Range (Canada):	20–90 psi (140 - 620 kPa)

Name of Substance	USEPA Max. Contaminant Level	pH	Flow Rate	Pressure
Barium	2.0 mg/L	7.5 + 0.5	21.0 gpm	15 (psig)
Radium 226/228	5 pCi/L	7.5 + 0.5	21.0 gpm	15 (psig)

This system is certified for barium and radium 226/228 reduction based on hardness reduction. It is recommended you test your water every six months to ensure the system is performing properly and that hardness, and therefore barium and radium 226/228, are being reduced. Hardness test strips have been included. Additional strips are available from your local Culligan dealer.

The Culligan Aquasential Smart High Efficiency Water Softener Model: HE-1.25-16 has been tested and certified by WQA against NSF/ANSI Standard 372, CSA B483.1, and NSF/ANSI Standard 44 for the effective reduction of hardness (calcium and magnesium), barium, and radium 226/228 as verified and substantiated by test data. To maintain product certification and ensure uniform performance, the product is retested on a consistent basis.



An efficiency rated water softener is a DIR softener which also complies with specific performance specifications intended to minimize the amount of regenerant brine and water used in its operation. Efficiency rated water softeners shall have a rated salt efficiency of not less than 3350 grains of total hardness exchange per pound of salt (based on NaCl equivalency) (477 grams of total hardness exchange per kilogram of salt), and shall not deliver more salt than its listed rating. The efficiency is measured by a laboratory test described in NSF/ANSI 44. The test represents the maximum possible efficiency the system can achieve. Operational efficiency is the actual efficiency achieved after the system has been installed. It is typically less than the efficiency due to individual application factors including water hardness, water usage, and other contaminants that reduce the softener's capacity.

Refer to the Specifications, Familiarization and Warranty section of this Owner's Guide (P/N 01040719) for more specific product information. To avoid contamination from improper handling and installation, your system should only be installed and serviced by your Culligan dealer. Performance will vary based on local water conditions. The substances reduced by this system are not necessarily in your water.

Culligan water softeners are designed to work with any salt of good quality, although it is recommended that you ask your local Culligan dealer for his suggestion on the best type and grade of salt to use in this softener.

NOTE! This softener is not intended to be used for treating water that is microbiologically unsafe or of unknown quality without adequate disinfection before or after the system.

† The efficiency rated dosage is only valid at the 16 lb salt dosage and maximum service flow rate for 16" models.

Records & Data

Important Information about your Culligan Water Softening System

Please fill in the information below for future reference. If you have any questions regarding your Culligan water system, please contact the dealer that installed your system for assistance.

Addition information may also be found by visiting: www.culligan.com

System and Dealer Identification

System Name _____

Model Name: _____

Control Valve Model # _____

Control Valve Serial # _____

Date of Installation: _____

Tank Serial # _____

Culligan Dealer: _____

City/Town: _____

Dealer Phone # _____

State: _____

System Settings

Time of Recharge _____ AM/PM

Recommended Culligan Service Interval:

Gallons Capacity Per Regeneration: _____

Annual: _____ Bi-Annual: _____

Day Override / Interval: _____

Owner Maintenance:

Salt Tank Capacity: _____

_____ Check Salt Level

Wi-Fi Signal Strength: _____

_____ Replace Cartridge Filter(s)

_____ Add Resin Cleaner

Water Analysis

Hardness _____ grains/gallon

Total Dissolved Solids - TDS _____ mg/l

pH level (acidity) _____ S.U.

Alkalinity _____ grains/gallon

Chloride _____ mg/l

Manganese _____ mg/l

Sodium _____ mg/l

Hydrogen Sulfide (H₂S) _____ mg/l

NOTE! mg/l (milligrams per liter) and ppm (parts per million) are equivalent units of measurement 1 grain = 17.1 mg/l

Culligan Limited Warranty

Culligan Aquasential Smart High Efficiency Water Conditioners

You have just purchased one of the finest water conditioners made. As an expression of our confidence in Culligan International Company products, your water conditioner is warranted to the original end-user, when installed in accordance with Culligan specifications, against defects in material and workmanship from the date of original installation, as follows:

For the LIFETIME of the original consumer purchaser	The Quadra-Hull™ conditioner tank and the Cullex® resin
For a period of TEN YEARS	Aquasential Smart High Efficiency circuit board, control valve body, excluding internal parts. The salt storage container, brine valve and all its component parts
For a period of FIVE YEARS	Soft-Minder® meter, Smart Brine probe, Salt Level Monitor, or Aqua-Sensor® probe, if so equipped.
For a period of ONE YEAR	The entire conditioner

If a part described above is found defective within the specified period, you should notify your independently operated Culligan dealer and arrange a time during normal business hours for the dealer to inspect the water conditioner on your premises. Any part found defective within the terms of this warranty will be repaired or replaced by the dealer. You pay only freight from our factory and local dealer charges.

We are not responsible for damage caused by accident, fire, flood, freezing, Act of God, misuse, misapplication, neglect, oxidizing agents (such as chlorine, ozone, chloramines and other related components), alteration, installation or operation contrary to our written instructions, or by the use of accessories or components which do not meet Culligan specifications, is not covered by this warranty. Warranty is void if system is installed outside a building without being rated for outdoor use. Refer to the specifications section in the Installation and Operating manual for application parameters.

Our product performance specifications are furnished with each water conditioning unit. TO THE EXTENT PERMITTED BY LAW, CULLIGAN DISCLAIMS ALL IMPLIED WARRANTIES, INCLUDING WITHOUT LIMITATION WARRANTIES OF MERCHANTABILITY AND FITNESS FOR PARTICULAR PURPOSE; TO THE EXTENT REQUIRED BY LAW, ANY SUCH IMPLIED WARRANTIES ARE LIMITED IN DURATION TO THE ONE-YEAR PERIOD SPECIFIED ABOVE FOR THE ENTIRE CONDITIONER. As a manufacturer, we do not know the characteristics of your water supply or the purpose for which you are purchasing a water conditioner. The quality of water supplies may vary seasonally or over a period of time, and your water usage rate may vary as well. Water characteristics can also differ considerably if your water conditioner is moved to a new location. For these reasons, we assume no liability for the determination of the proper equipment necessary to meet your requirements, and we do not authorize others to assume such obligations for us. Further, we assume no liability and extend no warranties, express or implied, for the use of this product with a non-potable water source. OUR OBLIGATIONS UNDER THIS WARRANTY ARE LIMITED TO THE REPAIR OR REPLACEMENT OF THE FAILED PARTS OF THE WATER CONDITIONER, AND WE ASSUME NO LIABILITY WHATSOEVER FOR DIRECT, INDIRECT, INCIDENTAL, CONSEQUENTIAL, SPECIAL, GENERAL, OR OTHER DAMAGES.

Some states do not allow the exclusion of implied warranties or limitations on how long an implied warranty lasts, so the above limitation may not apply to you. Similarly, some states do not allow the exclusion of incidental or consequential damages, so the above limitation or exclusion may not apply to you. This warranty gives you specific legal rights, and you may also have other rights which vary from state to state. Consult your telephone directory for your local independently operated Culligan dealer, or write Culligan International Company for warranty and service information.

Culligan International Company

9399 W. Higgins Rd., Suite 1100
Rosemont, IL 60018 USA
1-800-CULLIGAN or 1-847-430-2800
www.culligan.com